

DECLARATION OF COVENANTS, CONDITIONS AND RESTRICTIONS
FOR BLACKBIRD FARMS PLANNED DEVELOPMENT

Table of Contents

I.	Definitions	1
II.	Property Rights	4
	(1) General Description of Property Rights	4
	(2) Ownership of Common Area	5
	(3) Delegation of Use	6
	(4) Certain Encroachments and Easement	6
	(5) Easement for Utilities and Public and Quasi-Public Vehicles	7
III.	Association Membership and Voting Rights	9
	(1) Membership	9
	(2) Classes of Membership	9
	(3) Voting Rights of Classes	11
	(4) Functions	12
	(5) Board of Directors	13
IV.	Covenant for Maintenance Assessments	13
	(1) Purposes of Assessments	13
	(2) Annual Accounting	15
	(3) Proposed Annual Budget	15
	(4) Regular Assessments	17
	(5) Special Assessments	20
	(6) Regular Assessments Prior to the Applicable	21
	(7) Failure of Owner to Pay Assessments	24
	(8) Subordination of Assessment Lien to Mortgage	25
V.	Covenants and Restrictions	26
VI.	Amendment of Declaration	36
	(1) Generally	36
	(2) Amendments by Declarant Only	37
	(3) Amendment Prior to the Applicable Date	39
	(4) Approval of Amendments	39
VII.	Architectural Control	39
	(1) Architectural Control [®]	39
	(a) The Architectural Review Board	39
	(b) Purposes	40
	(c) Conditions	40
	(d) Procedures	40
	(e) Maintenance of Architectural Control	41

RECORDED IN RECORD

90-01518

1:20 O'CLOCK P M FEE 79⁰⁰

FEB 2 1990

Hollie High
RECORDER TIPPECANOE CO., IN

G+L Development / pick up

DULY ENTERED FOR TAXATION
SUBJECT TO FINAL ACCEPTANCE
FOR TRANSFER.

Sarah S. Brown
AUDITOR OF TIPPECANOE CO

2-2-90

VIII.	Insurance	41
	(1) Public Liability Insurance	41
	(2) Other Insurance	42
	(3) General Provisions	43
	(4) Insurance by Owners	43
	(5) Condemnation Awards	43
	(6) Restoration of Common Area	44
IX.	General Provisions	45
	(1) Acceptance and Ratification	45
	(2) Negligence	46
	(3) Costs and Attorneys' Fees	46
	(4) Waiver	46
	(5) Severability Clause	46
	(6) Pronouns	47
	(7) Interpretation	47
	(8) Enforcement	47

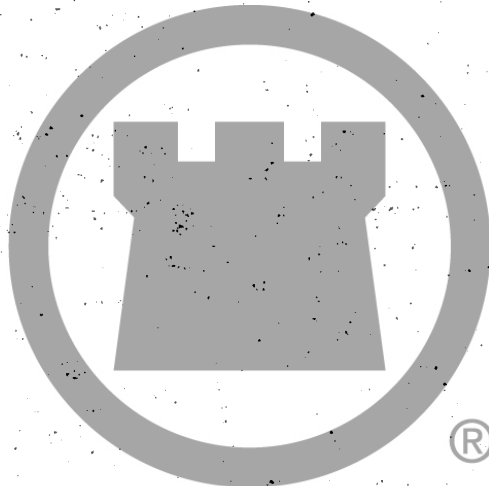

CHICAGO TITLE

DECLARATION
OF COVENANTS, CONDITIONS AND RESTRICTIONS
FOR BLACKBIRD FARMS PLANNED DEVELOPMENT

THIS DECLARATION, made on the date hereinafter set forth by Lafayette Bank & Trust Company, an Indiana corporation, hereinafter referred to as "Declarant",

WITNESSETH:

WHEREAS, Declarant is the owner of certain real estate in Wabash Township, Tippecanoe County, Indiana, which is more particularly described in the attached Exhibit A, which is incorporated herein by reference (the "Real Estate")

NOW, THEREFORE, Declarant hereby declares that the Real Estate described above shall be held, sold and conveyed subject to the following easements, restrictions, covenants and conditions, which are for the purpose of protecting the value and desirability of, and which shall run with, the Real Estate and be binding on all parties having any right, title or interest in the Real Estate or any part thereof, their heirs, successors and assigns, and shall inure to the benefit of each Owner thereof.

CHICAGO TITLE

ARTICLE I

DEFINITIONS

As used in this Declaration, the following terms shall have the following meanings, unless the context requires otherwise:

Section 1. "Articles" or "Articles of Incorporation" means the Articles of Incorporation of the Association. The Articles of Incorporation are incorporated herein by reference.

Section 2. "Association" means Blackbird Farms Homeowners Association, Inc., an Indiana not-for-profit corporation, its successors and assigns.

Section 3. "Blackbird Pond" means that body of water located in the Common Area, which is designed to handle the surface water drainage requirements of the Real Estate and is not to be construed to assure that water will be in the pond at all times or that any particular level of water will be contained therein.

Section 4. "Board of Directors" means the Board of Directors of the Association.

Section 5. "Bylaws" means the Bylaws of the Association. The Bylaws are incorporated herein by reference.

Section 6. "Common Area" means all of the area designated as Common Area and Limited Common Area on the recorded Final Detailed Plans of Blackbird Farms Planned Development, including Common Area Lots A, B, C and D and all other Common Area Lots shown on the Plans (as hereinafter defined), including but not limited to Blackbird Pond and embankment areas of Blackbird Pond, all landscaped areas, driveways, sidewalks, parking areas and recreational areas, if any, but excluding all Lots and dedicated streets. The Common Area

shall be conveyed to the Association, and (except with respect to the Limited Common Area, use of which is limited as provided elsewhere herein) is to be held for the common use and enjoyment of the Owners subject to the provisions hereof.

Section 7. "Common Expense" means expenses for administration of the Association and expenses for the upkeep, maintenance, repair and replacement of the Common Area and all other sums lawfully assessed against the Members of the Association, provided, however, that no expenditure for improvements to the Common Area in addition to the improvements shown on the Plans shall be deemed to be a Common Expense.

Section 8. "Declarant" means Lafayette Bank & Trust Company, its successors and assigns.

Section 9. "Dwelling Unit" means one of the living units located upon a Lot.

Section 10. "Lot" means any plot of ground designated as such upon the recorded Final Plans of Blackbird Farms Planned Development or any part thereof and upon which any one (1) Dwelling Unit is constructed, is to be constructed or has existed. The term Lot shall be deemed to include the Dwelling Unit, if any, located thereon.

Section 11. "Member" means a member of the Association.

Section 12. "Mortgagee" means the holder of a first mortgage lien upon a Lot.

Section 13. "Owner" means a person, firm, corporation, partnership, association, trust or other legal entity, or any combination thereof, who owns fee simple title to a Lot.

Section 14. "Plans" means the recorded Final Detailed Plans of Blackbird Farms Planned Development.

Section 15. "Real Estate" means that certain real estate described in the attached Exhibit A.

Section 16. "Limited Common Area" means the driveway areas abutting certain Lots, which are designated as Limited Common Area on the Plans and which will not be dedicated to the City of West Lafayette. The Limited Common Area may be used only for driveway purposes and only by the Owners of the Lots abutting such Limited Common Area, and the families, guests, lessees and invitees of such Owners.

ARTICLE II
PROPERTY RIGHTS

Section 1. General Description of Property Rights. Every Owner of a Lot within the Real Estate will obtain fee simple ownership of said Lot and of the improvements constructed thereon. The Association will perform certain regular maintenance tasks on the Common Area within the Real Estate. Every Owner will be required to perform all other repairs, replacements and maintenance on that Owner's Lot and upon the Dwelling Unit located thereon.

Section 2. Ownership of Common Area. The Common Area shall be conveyed to or owned by the Association, and shall be held for the use and enjoyment of the Owners, all of which shall have the right and easement of enjoyment and in to the Common Area (except the Limited Common Area, use of which is limited as provided elsewhere herein), which right shall pass with title to every Lot, subject to the provisions of this Declaration, including but not limited to the following:

(a) The right of the Association to suspend any Member from the right to use recreational facilities, if any, for any period during which any assessment against such Member's Lot remains unpaid.

(b) The right of the Association, upon approval by vote of at least sixty-seven percent (67%) of the Members, to dedicate or transfer all or any part of the Common Area to any public agency, authority or utility for such Common Area purposes and upon such conditions as may be acceptable to the Association, provided that any such dedication or transfer shall be subject to acceptance thereof by the public agency.

(c) The right of the Association or its Board of Directors to adopt such rules and regulations regarding use of the Common Area and recreational facilities, if any, by the Members.

(d) The right of the Association, in accordance with the Articles of Incorporation and Bylaws, to borrow for purposes of repairs, maintenance and replacement of improvements upon the Common Area.

Section 3. Delegation of Use. Any Owner may delegate, in accordance with the Bylaws, his right of enjoyment to the Common Area and facilities to the members of his family, his tenants or contract purchasers who reside on any Lot.

Section 4. Certain Encroachments and Easements. If by reason of inexactness of construction, settling after construction or for any other reason, any Common Area or improvement upon any Common Area encroaches upon any other Lot, an easement shall be deemed to exist and run to the Association for the maintenance, use and enjoyment of such Common Area. Further, if for said reasons any Dwelling Unit located upon Lots 82-188 encroaches upon the adjoining Lot by not more than one (1) foot, an easement shall be deemed to exist from the Owner of the Lot upon which said Dwelling Unit encroaches to the Owner of the encroaching Dwelling Unit. Each Owner of Lots

82-188 shall have an easement over and across any adjoining Lot for purposes of construction, maintenance and repair of such Owner's Dwelling Unit, provided that the Owner engaging in such construction, maintenance or repair shall upon conclusion of such work restore the adjoining Lot to its condition prior to commencement thereof. Each Owner shall have an easement in common with each other Owner to use all pipes, wires, ducts, cables, conduits, utility lines and other common facilities, if any, located in the Common Area and serving such Owner's Dwelling Unit. Notwithstanding the foregoing, no utility shall place any improvements or utility structures in any location upon the Real Estate which would interfere with other improvement shown on the Plans.

Section 5. Easement for Utilities and Public and Quasi-Public Vehicles. All quasi-public vehicles including, but not limited to, police, fire and other emergency vehicles, trash and garbage collection, post-office vehicles and privately owned delivery vehicles shall have the right to enter upon the Common Area in the Real Estate in the performance of their duties. Notwithstanding the foregoing, garbage trucks, street cleaning and snow removal equipment of the City of West Lafayette will provide service only upon the dedicated streets in the Real Estate and will not enter any of the Common Area driveways. All water, sewer, gas, electric, telephone and cable television utilities are to be underground. Street

lighting are to be provided as shown on the Plans. An easement is also granted to all utilities and their agents for ingress, egress, installation, replacement, repair and maintenance of such utilities, including but not limited to water, sewer, gas, telephone and electricity on the Real Estate; provided, however, nothing herein shall permit the installation of sewers, electric lines, water lines or other utilities except as initially designed and approved by Declarant on the Plans or as thereafter may be approved by Declarant or by the Board of Directors. By virtue of this easement all of the foregoing utility companies are expressly permitted to erect and maintain the necessary equipment on the Real Estate and to affix and maintain electrical and telephone wires, circuits and conduits on and under the roofs and exterior walls of Dwelling Units. If any utility furnishing service requests a specific easement by a separate recordable document, Declarant shall have the right to grant such easement upon the Real Estate without violating the terms hereof, provided that no such easement shall conflict with the Plans. The easements granted herein shall in no way affect any other recorded easement with respect to the Real Estate.

An easement is also granted to the Association, its officers, agents and employees and to any management company selected by the Association to enter upon or cross over any Lot or the Common Area to perform its duties.

ARTICLE III

ASSOCIATION MEMBERSHIP AND VOTING RIGHTS

Section 1. Membership. Every Owner of a Lot which is subject to assessment shall be a Member of the Association, provided, however, that the Declarant shall be a Member of the Association with respect to each Lot owned by the Declarant regardless whether such Lot is subject to assessment. Membership shall be appurtenant to each Lot and may not be separated from ownership of any Lot.

Section 2. Classes of Membership. The Association shall have three classes of membership:

Class A: Class A Members shall be all Owners of Lots 1 through 188 which are subject to assessment, except the Declarant, its successors and assigns. Ownership of one of said Lots shall be the sole qualification for Class A membership.

Class B: Class B Members shall be all Owners of Lots 189-191 which are subject to assessment, except the Declarant, its successors and assigns. Ownership of one of said Lots shall be the sole qualification for Class B membership.

Class C: Class C Members shall be Declarant and its successors and assigns. Class C membership shall apply to any Lot owned by Declarant, its successors

and assigns Class C membership shall cease and be converted to Class A membership (as to Lots 1-188) or Class B membership (as to Lots 189-191) upon the first to occur of the following dates (hereinafter referred to as the "Applicable Date"):

(a) the date when the written resignation of the Class C Member(s) as such is delivered to the registered agent of the Association; or

(b) the date when the total votes outstanding in Class A membership equal or exceed the total votes outstanding in Class C membership; or

(c) August 9, 1999.

The Class C membership of Declarant or its successors or assigns with respect to any individual Lot shall cease and be converted to Class A or Class B membership, as the case may be, upon actual occupancy of the Dwelling Unit located upon that Lot by any person other than Declarant, its successor or assigns. The Class A membership or Class B membership of an Owner shall terminate when such person ceases to be the Owner of such Lot, and shall be transferred to the new Owner of such Lot.

Section 3. Voting Rights of Classes.

Class A: Class A Members shall be entitled to cast one vote for each of Lots 1-188 owned by such Members on all matters submitted to a vote of the Members, provided, however, that the votes of the Class A members as a group shall be counted as sixty-six percent (66%) of the total votes of the Members of the Association.

Class B: Class B Members shall be entitled to cast one vote for each of Lots 189-191 owned by such Members on all matters submitted to a vote of the Members, provided, however, that the votes of the Class B members as a group shall be counted as thirty-four percent (34%) of the total votes of the Members of the Association.

Class C: The Class C Member(s) shall be entitled to cast three votes for each Lot they own on all matters submitted to a vote of the membership. Said votes shall be counted as Class A votes for each of Lots 1-188 owned by Class C Members and shall be counted as Class B votes for each of Lots 189-191 owned by Class C Members.

When more than one person is an Owner of a Lot, all such persons shall be Members in the applicable Class, but their total vote shall not exceed one per Lot owned, and such vote

shall be cast as one unit in such manner as the majority of the Owners of such Lot may agree. In the event such Owners fail to reach agreement, they shall not be entitled to vote and shall be considered as abstaining. In the event some of such Owners do not attend the meeting, in person or by proxy, those Owners who are in attendance, in person or by proxy, for purposes of determining the manner in which their vote shall be cast, shall be considered as the sole Owner of the Lot.

The Board of Directors may suspend the voting rights of a Member during any period in which such Member shall be in default in payment of any assessment levied by the Association.

Section 4. Functions. The Association has been formed for the purposes of providing for the maintenance, repair, upkeep, replacement, administration, operation and ownership of the Common Area, the enforcement of the covenants contained herein, the payment of taxes assessed against the Common Area, the payment of charges for utility service to the Common Area (including electricity for street lighting), and any other necessary expenses and costs in connection with the Common Area, except as otherwise limited hereby[®] and the performance of such other functions as may be designated to it to be performed under this Declaration. The Association also shall have the authority to enter into a recreational facilities lease with the owner of any recreational facilities located within the Real Estate, and to make those recreational facilities available to Owners upon such terms as are established by the Board of Directors.

Section 5. Board of Directors. The powers, limitations on powers, compensation, duties, qualifications, terms of office, method of election, method of removal and other provisions concerning the Board of Directors are as set forth in the Articles of Incorporation and the Bylaws. The Board of Directors shall be elected annually by the Members of the Association, in accordance with the procedures set forth in the Bylaws.

ARTICLE IV

COVENANT FOR MAINTENANCE ASSESSMENTS

Section 1. Purpose of Assessments. Maintenance, repairs, replacements and upkeep of the Common Area, including without limitation Blackbird Pond and all other drainage facilities upon the Real Estate, shall be provided by the Association as part of its duties, and the cost thereof shall constitute part of the Common Expense. Each Owner shall be responsible for maintaining and keeping such Owner's Lot and all improvements thereon in a good, clean and sanitary condition at such Owner's expense.

Notwithstanding any obligation or duty of the Association to repair or maintain the Common Area, if due to the willful, intentional or negligent acts or omissions of Owner or of a member of such Owner's family or a guest, tenant, invitee or other occupant or visitor of such Owner, damage shall be caused

to the Common Area, or if maintenance, repairs or replacements shall be required thereby which would otherwise be a Common Expense, then such Owner shall pay for such damage and such maintenance, repairs and replacements as may be determined by the Association unless such loss is covered by an insurance policy owned by the Association which contains a waiver of subrogation clause. If not paid by such Owner upon demand by the Association, the cost of repairing such damage shall be added to and become part of the assessment to which such Owner's Lot is subject.

If any Owner shall fail to maintain and keep such Owner's Lot or any part thereof in a good, clean and sanitary condition, exclusive of maintenance of the Dwelling Unit, the Association may perform any work necessary to do so and charge the Owner of such Lot for such cost, which cost shall be added to and become a part of the assessment to which such Owner's Lot is subject.

The assessments levied by the Association shall be used exclusively to promote the recreation, health, safety and welfare of the residents in the Real Estate and for the costs and expenses incident to operation of the Association, including without limitation snow removal for the Common Area, repair and replacement of improvements on the Common Area, and for payment of other Common Expenses as defined in the Bylaws.

Any fee charged to Owners by the Association for use of recreational facilities leased by the Association, if any, shall be deemed to be a part of the Regular Assessment (as hereinafter defined).

No expenditure for improvements to the Common Area in addition to the improvements shown on the Plans shall be deemed to be a Common Expense, and no assessment (other than a Special Assessment as hereinafter defined) shall be used to pay any expenditures for such additional improvements.

Section 2. Annual Accounting. Annually, after the close of each fiscal year of the Association and prior to the date of the annual meeting of the Association next following the end of such fiscal year, the Board of Directors shall cause to be prepared and furnished to each Owner a financial statement prepared by a certified public accountant or firm of certified public accountants then servicing the Association, which statement shall show all receipts and expenses received, incurred and paid by the Association during the preceding fiscal year. ®

Section 3. Proposed Annual Budget. Annually, before the date of the annual meeting of the Association, the Board of Directors shall cause to be prepared a proposed annual budget for the current fiscal year estimating the total amount of the Common Expenses for the current fiscal year and shall furnish a copy of such proposed budget to each Owner at or prior to the

time the notice of such annual meeting is mailed or delivered to such Owners. The annual budget shall be submitted to the Owners at the annual meeting of the Association for adoption, and, if so adopted, shall be the basis for the Regular Assessments (as hereinafter defined) for the current fiscal year. At the annual meeting of the Owners, the budget may be approved in a whole or in part or may be amended in whole or in part by a majority vote of the Owners; provided, however, that in no event shall the annual meeting of the Owners be adjourned until an annual budget is approved and adopted at such meeting, either the proposed annual budget or the proposed annual budget as amended. The annual budget, the Regular Assessments and all sums assessed by the Association shall be established by using generally accepted accounting principles applied on a consistent basis.

The annual budget may include the establishment and maintenance of a replacement reserve fund for replacement and repair of the Common Area, which replacement reserve fund (if established) shall be used for those purposes and not for usual and ordinary repair expenses. Such replacement reserve fund for replacement and repair of the Common Area shall be maintained by the Association in a separate interest bearing account or accounts with one or more banks or savings and loan associations authorized to conduct business in Tippecanoe County, Indiana selected from time to time by the Board of Directors.

The failure or delay of the Board of Directors to prepare a proposed annual budget and to furnish a copy thereof to the Owners shall not constitute a waiver or release in any manner of the obligations of the Owners to pay the Common Expenses as herein provided, whenever determined. Whenever, whether before or after the annual meeting of the Association, there is no annual budget approved by the Owners as herein provided for such current fiscal year, the Owners shall continue to pay Regular Assessments based upon the last approved budget or, at the option of the Board of Directors, based upon one hundred and ten percent (110%) of such last approved budget, as a temporary budget.

Section 4. Regular Assessments. The annual budget as adopted by the Owners shall, based on the estimated cash requirement for the common Expenses in the fiscal year as set forth in said budget, contain a proposed assessment against each Lot. Sixty-six percent (66%) of the total amount of any Regular Assessment or Special Assessment (as hereinafter defined) shall be assessed against Lots 1-188, and thirty-four percent (34%) thereof shall be assessed against Lots 189-191. The amount assessed against Lots 1-188 shall be divided equally among said Lots, and the amount assessed against Lots 189-191 shall be divided equally among said Lots. Immediately following the adoption of the annual budget, each Owner shall be given written notice of such assessment against his

respective Lot (herein called the "Regular Assessment"). In the event the Regular Assessment for a particular fiscal year is initially based upon a temporary budget, such Regular Assessment shall be revised, within fifteen (15) days following adoption of the final annual budget by the Owners, to reflect the assessment against each Lot based upon such annual budget as finally adopted by the Owners. The aggregate amount of the Regular Assessments shall be equal to the total amount of expenses provided and included in the final annual budget, including any reserve funds as hereinabove provided. The Regular Assessment against each Lot shall be paid in advance in equal monthly installments commencing on the first day of the first month of each fiscal year and monthly thereafter through and including the first day of the last month of such fiscal year. Payment of the monthly installments of the Regular Assessment shall be made to the Board of Directors or any Managing Agent, as directed by the Board of Directors; provided, however, Owners may elect to pay assessments quarterly, semi-annually or annually, in advance. In the event the Regular Assessment for a particular fiscal year of the Association was initially based upon a temporary budget:

- (i) if the Regular Assessment based upon the final annual budget adopted by the Owners exceeds the amount of the Regular Assessment based upon the temporary budget, that portion of such excess applicable to the period from the first day of the current fiscal year to the date of the next

payment of the Regular Assessment which is due shall be paid with such next payment, and all payments thereafter during such fiscal year, shall be increased so that the Regular Assessment as finally determined shall be paid in full by the remaining payments due in such fiscal year, or

- (ii) if the Regular Assessment based upon the temporary budget exceeds the Regular Assessment based upon the final annual budget adopted by the Owners, such excess shall be credited against the next payment or payments of the Regular Assessment coming due, until the entire amount of such excess has been so credited;

provided, however, that if an Owner had paid his Regular Assessment either quarterly, semi-annually or annually in advance, then the adjustments set forth under (i) or (ii) above shall be made by a cash payment by, or refund to, the Owner on the first day of the second month following the determination of the Regular Assessment based upon the annual budget finally adopted by the Owners.

The Regular Assessment for the current fiscal year of the Association shall become a lien on each Lot as of the first day of each fiscal year of the Association, even though the final determination of the amount of such Regular Assessment may not have been made by that date. The fact that an Owner has paid his Regular Assessment for the current fiscal year in whole or in part based upon a temporary budget and thereafter, before the annual budget and Regular Assessment are finally determined, approved and adjusted as herein provided, sells, conveys or transfers his Lot or any interest therein, shall not relieve or release such Owner or his successor as Owner of such

Lot from payment of the Regular Assessment for such Lot as finally determined, and such Owner and his successor as Owner of such Lot shall be jointly and severally liable for the Regular Assessment as finally determined. Any statement of unpaid assessments furnished by the Association pursuant hereto prior to the final determination and adoption of the annual budget and Regular Assessment for the year in which such statement is made shall state that the matters set forth therein are subject to adjustment upon determination and adoption of the final budget and Regular Assessment for such year, and all parties to who any such statement may be delivered or who may rely thereon shall be bound by such final determinations. Monthly installments of Regular Assessments shall be due and payable automatically on their respective due dates without any notice from the Board of Directors or the Association, and neither the Board of Directors nor the Association shall be responsible for providing any notice or statements to Owners for the same.

Section 5. Special Assessments. From time to time Common Expenses of an unusual or extraordinary nature or not otherwise anticipated may arise. At such time and provided that any such assessment shall have the assent of sixty-seven percent (67%) of all Members who are voting in person or by proxy at a meeting duly called for this purpose. The Board of Directors shall have the full right, power and authority to make special

assessments which, upon resolution of the Board of Directors, shall become a lien on each Lot, divided among Lots in the same manner as is set forth above with respect to Regular Assessments (hereinafter referred to as "Special Assessment"). Without limiting the generality of the foregoing provisions, Special Assessments may be made by the Board of Directors from time to time to pay for capital expenditures and to pay for the cost of any repair or reconstruction of damage caused by fire or other casualty or disaster to the extent insurance proceeds are insufficient therefor under the circumstances described in this Declaration.

Section 6. Regular Assessments Prior to the Applicable Date. During the period that Dwelling Units are being constructed within the Real Estate, it is difficult to accurately allocate the Common Expenses to the individual Lots. The purpose of this Section is to provide the method of the payment of the Common Expenses during the period prior to the Applicable Date to enable the Association to perform its duties and functions. Accordingly, and notwithstanding any other provision contained in the Declaration, the Articles or the Bylaws or otherwise, prior to the Applicable Date, the annual budget and all Regular Assessments and Special Assessments shall be established by the Initial Board of Directors without any meeting or concurrence of the Owners; provided, however, the Regular Assessments shall be determined in accordance with the provisions contained in this Section.

The Association will enter into a management agreement with Declarant (or a corporation or other entity designated by Declarant) (hereinafter referred to as "Management Agent" or "Managing Agent") in accordance with the provisions of this Declaration. So long as such management agreement (or any similar agreement) remains in effect, the Common Expenses and Regular Assessments shall be paid by Owners to Management Agent. Declarant agrees that until the earlier of (1) the termination of said management agreement or (2) 1 year after the date of execution thereof, the monthly Regular Assessment shall not exceed _____ (\$____) (the "Guaranteed Charge"). After this date (assuming that said management agreement or similar agreement is still in effect) and so long thereafter as said management agreement (or similar agreement) remains in effect and the Management Agent continues to perform such functions, Declarant guarantees that the monthly Regular Assessment shall not exceed the amount of the Guaranteed Charge plus a maximum of a _____ percent (___%) increase in the Guaranteed charge for each year. Such adjustments to the Guaranteed Charge (up to _____ percent (___%) increase as determined by the Board of Directors) shall be made annually on January 1 of each year so long as said management agreement remains in effect and the Management Agent continues to perform such functions. Payment of Such monthly charge shall during such guaranteed period entirely defray the Owner's entire

obligation for his share of Common Expenses and shall be the Owner's entire Regular Assessment. Declarant shall be responsible for any deficit during such guarantee period; provided, however, that this guarantee is not intended to include, and does not include, major physical alterations or other capital expenditures not ordinarily anticipated in normal maintenance operations. Such expenditures, if any, must be covered through Special Assessments.

That portion of the Regular Assessment collected by Declarant prior to the Applicable Date applicable to any replacement reserve created shall be held by the initial Board of Directors and if required, applied to the replacement of Common Areas. To the extent that any such replacement reserve is not so applied, the balance thereof shall be retained by the Association at the Applicable Date.

Payment of Regular Assessment prior to the Applicable Date with respect to each Lot not owned by Declarant shall commence on the date of conveyance by Declarant to such new Owner. The first payment shall be payable on the date of conveyance prorated to the first day of the calendar month next ensuing. Thereafter, payment of the Regular Assessment shall be paid the first day of each calendar month during the period prior to the Applicable Date. **CHICAGO TITLE** [®] NOTWITHSTANDING ANY PROVISIONS HEREIN TO THE CONTRARY, DECLARANT SHALL NOT BE RESPONSIBLE FOR REGULAR OR SPECIAL ASSESSMENTS FOR LOTS OWNED BY DECLARANT AND NOT OCCUPIED, OTHER THAN BY DECLARANT, SO LONG AS THE CLASS C MEMBERSHIP IS IN EXISTENCE.

Each Owner hereby authorizes the Association and the Board of Directors and its officers to enter into the management agreement described in this Declaration and to adhere to and abide by the same.

Section 7. Failure of Owner to Pay Assessments. No Owner may exempt himself from paying Regular Assessments and Special Assessments or from contributing toward the Common Expense or toward any other expense lawfully agreed upon by waiver of the use or enjoyment of the Common Area or by abandonment of the Lot belonging to him. Each Owner shall be personally liable for the payment of all Regular and Special Assessments. Where the Owner constitutes more than one person the liability of such persons shall be joint and several. If any Owner shall fail, refuse or neglect to make any payment of any Regular Assessment or Special Assessment when due, the lien for such assessment on the Owner's Lot and Dwelling Unit may be filed and foreclosed by the Board of Directors for and on behalf of the Association as a mortgage on real property or as otherwise provided by law. Upon the failure of the Owner to make timely payments of any Regular Assessment or Special Assessment when due the Board of Directors may in its discretion accelerate the entire balance of unpaid assessments for the current fiscal year and the Owner and any occupant of the Lot and Dwelling Unit shall be jointly and severally liable for the payment to the Association and the Board of Directors shall be entitled to

the appointment of a receiver for the purpose of preserving the Lot and Dwelling Unit and to collect the rentals and other profits therefrom for the benefit of the Association to be applied to the unpaid Regular Assessments or Special Assessments. The Board of Directors may at its option bring suit to recover a money judgment for any unpaid Regular Assessment or Special Assessment without foreclosing or waiving the lien securing the same. Any action to recover a Regular Assessment or Special Assessment whether by foreclosure or otherwise the Board of Directors for and on behalf of the Association shall be entitled to recover from the Owner of the respective Lot and Dwelling Unit costs and expenses of such action incurred (including but not limited to reasonable attorneys fees) and interest from the date such assessments were due until paid at the rate equal to the prime interest rate then being charged by Lafayette Bank & Trust Company, Lafayette, Indiana its largest and best corporate customer (or if said bank is no longer in existence then such rate charged by another national bank in Tippecanoe County, Indiana selected by the Board of Directors).

Section 8. Subordination of Assessment Lien to Mortgage.

Notwithstanding anything contained in this Declaration, the Articles or the Bylaws, any sale or transfer of a lot to a Mortgagee pursuant to a foreclosure on its mortgage or conveyance in lieu thereof, or a conveyance to any person at a

public sale in a manner provided by law with respect to mortgage foreclosure shall extinguish the lien of any unpaid installment of any Regular Assessment or Special Assessment as to such installment which became due prior to such sale, transfer or conveyance; provided, however, that the extinguishment of such lien cannot relieve the prior Owner from personal liability therefor. No such sale, transfer or conveyance shall relieve the Lot and Dwelling Unit or the purchaser at such foreclosure sale or grantee in the event of conveyance in lieu thereof, from liability for any installments of Regular Assessments or Special Assessments thereafter becoming due or from the lien therefor. Such unpaid share of any Regular Assessments or Special Assessments, the lien for which has been divested as aforesaid shall be deemed to be a Common Expense collectible from all Owners (including the party acquiring the subject Lot from which it arose).



ARTICLE V

COVENANTS AND RESTRICTIONS

The following covenants and restrictions on the use and enjoyment of the Lots, Dwelling Units and Common Area shall be in addition to any other covenants or restrictions contained herein and in the Final Plans, and all such covenants and restrictions are for the mutual benefit and protection of the present and future Owners and shall run with the land and inure

to the benefit of and be enforceable by any Owner, or by the Association. Any conflict between this Declaration and the Plans shall be controlled by the Plans. Present or future Owners or the Association shall be entitled to injunctive relief against any violation or attempted violation of any such covenants and restrictions, and shall, in addition, be entitled to damages for any injuries or losses resulting from any violations thereof, but there shall be no right of reversion or forfeiture resulting from such violation. These covenants and restrictions are as follows:

Section 1. Subject to U.S. Postal Regulations, the Declarant reserves the right to approve the type of mailboxes installed on the Real Estate.

Section 2. All Lots and Dwelling Units shall be used exclusively for residential purposes and for occupancy by a single family, except the Lots 189-191, which shall be used for multi-family apartment buildings. Except as hereinafter provided, no structure shall be erected or placed on any of Lots 1-188 other than one single-family dwelling and a private garage for two vehicles. The total living area of a one-story Dwelling Unit on Lots 1-81 shall be not less than 1400 square feet and the total living area of a two-story dwelling house on Lots 1-81 shall be not less than 1800 square feet. The total living area of a one-story Dwelling Unit on Lots 82-188 shall be not less than 1350 square feet and the total living area of

a two-story dwelling house on Lots 82-188 shall be not less than 1500 square feet. The foregoing square footage minimums are exclusive, in all cases, of porches, decks, patios, garages and similar areas not regarded as living areas.

The total foundation area (including garage) of a Dwelling Unit on Lots 1-81 shall be not greater than thirty percent (30%) of the total foundation area of the Lot upon which such Dwelling Unit is constructed. The total foundation area (including garage) of a Dwelling Unit on Lots 82-188 shall be not greater than forty percent (40%) of the total foundation area of the Lot upon which such Dwelling Unit is constructed.

Each Dwelling Unit on Lots 1-188 shall have a garage capable of housing at least two automobiles, and no Dwelling Unit upon Lots 82-188 shall have a garage capable of housing more than two automobiles. Other structures which are consistent with the high-quality residential character of the neighborhood may be erected or placed on Lots only with the express written approval of the the Architectural Review Board as hereinafter described. No changes in the exterior dimensions of Dwelling Units located on Lots 82-188 shall be made without approval of the Architectural Review Board.

On Lots 82-188, Dwelling Units may be constructed shall be constructed nearer than twelve (12) feet from the Lot line opposite the Lot line used as a "zero lot line"

Section 3. Real estate taxes are to be separately assessed and taxed to each Lot. Any real estate taxes or other assessments which are chargeable against the Common Area shall be paid by the Association and treated as a Common Expense.

Section 4. Each Owner shall pay for his own utilities which are separately metered. Utilities which are not separately metered, if any, shall be treated as and paid as part of the Common Expense unless otherwise determined by the Association.

Section 5. All driveways shall be of concrete or blacktop construction and shall be built no later than thirty (30) days after a new dwelling is occupied, weather permitting.

Section 6. No permanent outside clothesline shall be erected, placed or allowed to remain on the Real Estate.

Section 7. No Owner shall permit anything to be done or kept in his Dwelling Unit or on his Lot or on any of the Common Area which will result in a cancellation of insurance or increase in insurance on any part of the Common Area, or which would be in violation of any law or ordinance or the requirements of any insurance underwriting or rating bureau.

Section 8. No nuisance shall be permitted and no waste shall be committed in any Dwelling Unit, the Common Area or on any Lot. The Board of Directors determination as to what is a nuisance shall be conclusive.

Section 9. No Owner shall cause or permit anything to be hung or displayed on the outside of the windows of his Dwelling Unit or placed on the outside walls of any building, and no sign, awning, canopy or radio or television antenna or other attachment or thing shall be affixed to or placed upon the exterior walls or roofs or any other parts of any building without the prior written consent of the Architectural Review Board.

Section 10. No animals, livestock or poultry of any kind shall be raised, bred or kept in any Dwelling Unit or on any Lot or any of the Common Area, except that pet dogs, cats or customary household pets may be kept in a Dwelling Unit, provided that such pet is not kept, bred or maintained for any commercial purpose, and does not create a nuisance. Pets shall be taken outdoors only under leash or other restraint and while attended by its owner and an Owner shall be fully liable for any injury or damage to persons or property, including the Common Area caused by his pet. The Board of Directors may adopt such other rules and regulations regarding pets as it may deem necessary from time to time. Any pet which, in the judgment of the Board of Directors, is causing or creating a nuisance or unreasonable disturbance or noise, shall be permanently removed from the Real Estate within ten (10) days after written notice from the Board of Directors to the respective Owner to do so.

Section 11. The common Area shall be kept free and clear of rubbish, debris and other unsightly materials.

Section 12. Except for management of the affairs of the Association, no industry, business, trade, occupation or profession of any kind shall be conducted, maintained or permitted on the Real Estate; provided, however, this restriction shall not be construed to prevent an Owner from (a) maintaining his professional library therein; (b) keeping his personal, business or professional records or accounts therein; or (c) handling his personal business or professional telephone calls or correspondence therein. Such uses are expressly declared customarily incident to the principal residential use and not in violation of any restrictions under this Section.

Section 13. "For sale," "for rent" or "for lease" signs may be displayed upon the Real Estate only for reasonable periods and only upon the Lot to which such sign relates. No other sign or other window or advertising display shall be maintained or permitted on any part of the Real Estate, any Lot or any dwelling Unit without the prior consent of the Board of Directors; provided, however, that the right is reserved by the Declarant and the board to place or allow to be placed "for sale" or "for lease" and other signs on or about the Real Estate in connection with any unsold or unoccupied Lots and Dwelling Units.

Section 14. All Owners and members of their families, their guests, or invitees, and all occupants of any Dwelling Unit or other persons entitled to use the same and to use and enjoy the Common Area or any part thereof, shall observe and be governed by such rules and regulations as may from time to time be promulgated and issued by the Board of Directors governing the operation, use and enjoyment of the Common Area.

Section 15. No repair work shall be done on the Real Estate on any vehicles, including passenger automobiles. No truck of any kind that requires a "truck license", no boat or trailer and no unlicensed vehicle shall be parked or permitted to remain on any Lot or any Common Area unless the same is enclosed by a garage and not exposed to view. Trucks making deliveries or present in connection with service, repair or construction within the Real Estate are excepted. Other vehicles of any kind except conventional passenger cars shall not be parked or permitted to remain on any Lot or any Common Area for a period in excess of forty-eight (48) hours unless enclosed by a garage and not exposed to view. The purpose of this restriction is to preserve the overall appearance and integrity of the neighborhood. The parking restrictions set forth herein may be altered, amended or supplemented by the Board of Directors, provided that all such alterations, amendments and supplements shall be designed to achieve the purposes set forth in the preceding sentence.

Section 16. No Owner shall be allowed to plant trees, landscape or do any gardening in any of the Common Area, except with express permission from the Board of Directors.

Section 17. The Common Area shall be used and enjoyed only for the purposes for which it is designed and intended, and shall be used subject to the rules and regulations from time to time adopted by the Board of Directors.

Section 18. No boats shall be permitted on the Lake.

Section 19. No swimming shall be permitted in the Lake.

Section 20. No Owner may rent or lease his Dwelling Unit for transient or hotel purposes.

Section 21. No noxious or offensive trade or activity shall be carried on upon any of the Real Estate, nor shall anything be done thereon which may be or become an annoyance or nuisance to the neighborhood. No property shall be used or maintained as a dumping ground for rubbish. Trash, garbage or other waste shall be kept in sanitary containers. All equipment for the storage or disposal of such material shall be kept in a clean and sanitary condition and out of view of other Lots and the street, except that garbage containers may be placed within view for the purpose of garbage pick-up.

Section 22. Any Owner who leases a Dwelling Unit shall lease the entire Dwelling Unit and shall have a written lease which shall provide that the lease is subject to the provisions of the Declaration and any failure of the lessee to comply with

the terms of the Declaration, shall be a default under the lease. A copy of each such lease shall be provided to the Association.

Section 23. The Board of Directors from time to time may promulgate further rules and regulations concerning the use of Lots and the Common Area. Copies of rules and regulations shall be furnished by the Board of Directors to the Owners prior to the time when they shall be effective.

Section 24. No-access easements are hereby reserved as shown on the Plans. Along these lines, no vehicular access shall be permitted to or from the adjoining streets. This restriction may be enforced by the Tippecanoe County Area Plan Commission and shall be irrevocable except with the prior approval of the Tippecanoe County Area Planning Commission.

Section 25. Lots 25-28, 34-36 and 38-44 in the Real Estate are subject to a reservation of a forty (40) foot wide strip of land along the eastern boundary of said Lots as shown on the Plans, for street right-of-way purposes. No structures may be placed within the reserved area of said Lots. If within five (5) years after the date of recordation of the Plans said reserved area has neither been acquired by a public body or agency nor have condemnation proceedings been commenced against said reserved area, the reserved designation shall be deemed removed from said reserved area without further action by Declarant or any other party. Owners of the reserved area shall be responsible for maintenance thereof.

Section 26. No Dwelling Unit shall be located nearer to the Lot line of any Lot in the Real Estate than the building setback lines shown on the Plans, provided that the following additional restriction shall apply to Lots 1-81: any garage constructed upon any corner Lot and having a vehicular access door facing the side street shall be located no nearer than twenty (20) feet from the side Lot line.

Notwithstanding anything to the contrary contained herein or in the Articles or Bylaws, including, but not limited to, any covenants and restrictions set forth herein or otherwise, Declarant shall have the right to use and maintain any Lots and Dwelling Units owned by Declarant and other portions of the Real Estate (other than individual Dwelling Units and Lots owned by Persons other than Declarant), all of each number and size and at such locations as Declarant in its sole discretion may determine, as Declarant may deem advisable or necessary in its sole discretion to aid in the construction of Dwelling Units and the sale of Lots and Dwelling Units or for the conducting of any business or activity attendant thereto, including, but not limited to, model Dwelling Units, storage areas, construction yards, signs, construction offices, sales offices, management offices and business offices. Declarant shall have the right to relocate any or all of the same from time to time as it desires. At no time shall any of such facilities so used or maintained by Declarant be or become part

of the Common Area, unless so designated by Declarant, and Declarant shall have the right to remove the same from the Real Estate at any time. Notwithstanding the foregoing, Declarant's use of the Real Estate as provided above shall be limited to uses directly related to sale of Lots in the Real Estate, and development, construction and management of the Real Estate.

ARTICLE VI

AMENDMENT OF DECLARATION

Section 1. Generally. Except as otherwise provided in this Declaration, amendments to this Declaration shall be proposed and adopted in the following manner:

- (i) Notice. Notice of the subject matter of any proposed amendment shall be included in the notice of the meeting at which the proposed amendment is to be considered.
- (ii) Resolution. A resolution to adopt a proposed amendment may be proposed by the Board of Directors or by Owners having in the aggregate at least a majority of the votes of all Owners.
- (iii) Meeting. The resolution concerning a proposed amendment must be adopted by the designated vote at a meeting duly called and held in accordance with the provisions of the Bylaws.
- (iv) Adoption. Any proposed amendment to this Declaration must be approved by a vote of not less than seventy-five percent (75%) in the aggregate of the votes of all Owners.
- (v) Special Amendments. No amendment to this Declaration shall be adopted which changes (1) the applicable share of an Owner's liability for the Common Expenses, or the method of determining the same, or (2) the provision of this Declaration with respect

to casualty insurance or fidelity bonds to be maintained by the Association, or (3) the provisions of this Declaration with respect to reconstruction or repair of the Common Area in the event of Fire or any other casualty or disaster, or (4) the provisions of this Declaration establishing the Architectural Review Board and providing for its functions, or (5) the provisions of this Declaration with respect to the commencement of assessments on any Lot, without, in each and any of such circumstances, the unanimous approval of all Owners .

(vi) Additional Special Amendments. No amendment to this Declaration shall be adopted which imposes a right to first refusal or similar restriction or which changes (1) the method of voting, or (2) reserves for and responsibility for maintenance, repair and replacement of the Common Area, or (3) annexation of property to the Real Estate, or (4) the leasing of Dwelling Units, or (5) termination of the applicability of this Declaration, without the consent of at least ninety percent (90%) of the votes of the Owners for the first twenty (20) years after recording of this Declaration and thereafter at least seventy-five percent (75%) of the votes of Owners.

(vii) Recording. Each amendment to the Declaration shall be executed by the President and Secretary of the Association and shall be recorded in the office of the Recorder of Tippecanoe County, Indiana, and such amendment shall not become effective until so recorded.

Section 2. Amendments by Declarant Only. Notwithstanding the foregoing or anything elsewhere contained herein or in any other documents, the Declarant shall have and hereby reserves the right and power acting alone and without the consent or approval of the Owners, the Association, the Board of Directors, any Mortgagee or any other person to amend or

supplement this Declaration at any time and from time to time if such amendment or supplement is made (a) to comply with requirements of the Federal National Mortgage Association, the Government National Mortgage Association, the Federal Home Loan Mortgage Corporation, the Department of Housing and Urban Development, or any other governmental agency or any other public, quasi-public or private entity which performs (or may in the future perform) functions similar to those currently performed by such entities, (b) to induce any of such agencies or entities to make, purchase, sell, insure or guarantee first mortgages covering lots and Dwelling Units, (c) to bring this declaration into compliance with any requirements of applicable statutes, regulations or ordinances or (d) to correct clerical or typographical errors in this Declaration or any Exhibit hereto or any supplement or amendment thereto or (e) for any other reason. In furtherance of the foregoing, a power coupled with an interest is hereby reserved and granted to the Declarant to vote in favor of, make, or consent to any such amendments on behalf of each Owner as proxy or attorney-in-fact, as the case may be. Each deed, mortgage, trust deed, [®] other evidence of obligation, or other instrument affecting a Lot or Dwelling Unit and the acceptance thereof shall be deemed to be a grant and acknowledgment of, and a consent to the reservation of, the power to the Declarant to vote in favor of, make, execute and record any such amendments. The right of the Declarant to act

pursuant to rights reserved or granted under this Section shall terminate at such time as the Declarant no longer hold or controls title to any part or portion of the Real Estate.

Section 3. Amendment Prior to the Applicable Date.

Notwithstanding anything to the contrary contained herein, there shall be no amendment of the Declaration prior to Applicable Date without the consent and approval of Declarant.

Section 4. Approval of Amendments. Notwithstanding

anything to the contrary contained herein, there shall be no amendment of the Declaration with respect to project design, including the placement or nature of buildings, roadways, utilities or landscaping, without the prior approval of the Tippecanoe County Area Planning Commission.

ARTICLE VII

ARCHITECTURAL CONTROL

Section 1. Architectural Control.

(a) The Architectural Review Board. as a standing committee of the Association, there shall be, and hereby is, established an Architectural Review Board® consisting of three (3) or more persons as may, from time to time, be provided in the Bylaws. Until the Applicable Date, the Architectural Review Board shall be the Initial Board of Directors. After the Applicable Date, the Architectural Review Board shall be appointed by the Board of Directors.

(b) Purposes. The Architectural Review Board shall regulate the external design, appearance, use and location of improvements on the Real Estate in such manner as to preserve and enhance values and to maintain a harmonious relationship among structures, improvements and the natural vegetation and topography.

(c) Conditions. No improvements, alterations, repairs, excavation, changes in grade or other work which in any way alters the exterior of any Lot or the improvements located thereon from its natural or improved state existing on the date such Lot was first conveyed in fee by the Declarant to an Owner shall be made or done without the prior approval of the Architectural Review Board, except as otherwise expressly provided in this Declaration. No building, fence, wall, Dwelling Unit, or other structure shall be commenced, erected, maintained, improved, altered, made or done on any Lot without the prior written approval of the Architectural Review Board.

(d) Procedures. In the event the Architectural Review Board fails to approve, modify or disapprove in writing an application within thirty (30) days after such application (and all plans, drawings, specifications and other items required to be submitted to it in accordance with such rules as it may adopt) have been given to it, approval will be deemed granted by the Architectural Review Board. A decision of the Architectural Review Board may be appealed to the Board of

Directors which may reverse or modify such decision by a two-thirds (2/3) vote of the Directors then serving. The Architectural Review Board may establish committees consisting of two (2) or more of its members, which committees shall exercise such powers of the board as may be delegated to them.

(e) Maintenance of Architectural Control. The Association may not waive or abandon the procedure for regulating and enforcing the architectural design of the Dwelling Units nor for maintaining the Common Area (including the upkeep of common fences, driveways, lawns and plantings) without the prior written approval of all Owners.

ARTICLE VIII

INSURANCE

Section 1. Public Liability Insurance. The Association shall also purchase a master comprehensive public liability insurance policy in such amount or amounts as the Board of Directors shall deem appropriate from time to time but not less than \$1,000,000 for bodily injury, including deaths of persons and property damage arising out of a single occurrence. Such comprehensive public liability insurance policy shall cover the Association, the Board of Directors, any committee or organ of the Association or Board of Directors, any Managing Agent appointed or employed by the Association, all persons acting or who may come to act as agents or employees of any of the foregoing with respect to the Real Estate, all Owners of Lots and

all other persons entitled to occupy any Lot or Dwelling Unit. Such public liability insurance policy shall contain a "severability of interest" clause or endorsement which shall preclude the insurer from denying the claim of an Owner because of negligent acts of the Association or other Owners. Such public liability insurance policy shall contain a provision that such policy shall not be cancelled or substantially modified without at least ten (10) days written notice to the Association.

Section 2. Other Insurance. The Association shall also obtain any other insurance required by law to be maintained, including but not limited to workmen's compensation and occupational disease insurance, and such other insurance as the Board of Directors shall from time to time deem necessary, advisable or appropriate, including, but not limited to, liability insurance on vehicles owned or lease by the corporation and officers' and directors' liability policies. Such insurance coverage shall also provide for and cover cross liability claims of one insured party against another insured party. Such insurance shall inure to the benefit of each Owner, the Association, the Board of Directors and any [®] Managing Agent acting on behalf of the Association. Each Owner shall be deemed to have delegated to the Board of Directors his right to adjust with the insurance companies all losses under the policies purchased by the Board of Directors policies purchased by the Board of Directors the proceeds of which are payable to the Board of Directors or the Association.

Section 3. General Provisions. The premiums for all insurance hereinabove described shall be paid by the Association as part of the Common Expenses. When any such policy of insurance hereinabove described has been obtained by or on behalf of the Association, written notice of the obtainment thereof and of any subsequent changes therein or termination thereof shall be promptly furnished to each Owner, which notice shall be furnished by the officer of the Association who is required to send notices of meetings of the Association. Under no circumstances shall any distribution of insurance proceeds or condemnation awards be made by the Association to any Owners if to do so would be in violation of the Indiana Not-For-Profit Corporation Act or if the same would constitute a distribution of earnings, profits or pecuniary gain to the members of the Association; in any such event, any such insurance proceeds or condemnation awards shall be retained by the Association for use in the payment of Common Expenses.

Section 4. Insurance by Owners. Each Owner shall have the right to purchase such additional insurance at his own expense as he may deem necessary. ®

Section 5. Condemnation Awards. All proceeds payable as a result of condemnation shall be paid to the Association who shall act as trustee and hold such proceeds for the benefit of the individual Owners.

Section 6. Restoration of Common Area. In the event of damage to or destruction of any of the Common Area due to fire or any other casualty or disaster, the Association shall promptly cause the same to be repaired and reconstructed. The proceeds of insurance carried by the Association, of any, shall be applied to the cost of such repair and reconstruction.

In the event the insurance proceeds, if any, received by the Association as a result of any such fire or any other casualty or disaster are not adequate to cover the cost of repair and reconstruction of the Common Area, or in the event there are no insurance proceeds, the cost for restoring the damage and repairing and reconstructing the Common Area so damaged or destroyed (or the costs thereof in excess of insurance proceeds received, if any) shall be assessed by the Association against all of the Owners in the same manner as is used for Regular Assessments. Any such amounts assessed against the Owners shall be assessed as part of the Common Expenses and shall constitute a lien from the time of assessment as provided herein.

For purposes of this Article, repair, reconstruction and restoration shall mean construction or rebuilding the Common Area to as near as possible the same condition as they existed immediately prior to the damage or destruction and with the same type of architecture.

ARTICLE IX

GENERAL PROVISIONS

Section 1. Acceptance and Ratification. All present and future Owners, Mortgagees, tenants and occupants of the Lots shall be subject to and shall comply with the provisions of this Declaration, the Articles of Incorporation, and the Bylaws incorporated herein by reference, and the rules and regulations as adopted by the Board of Directors as each may be amended from time to time. The acceptance of a deed of conveyance or the act of occupancy of any Lot shall constitute an agreement that the provisions of this Declaration, the Articles of Incorporation, the Bylaws, and rules and regulations, as each may be amended or supplemented from time to time, are accepted and ratified by such Owner, tenant or occupant, and all such provisions shall be covenants running with the land and shall be binding on any person having at any time any interest or estate in a Lot or the Real Estate as though such provisions were recited and stipulated at length in each and every deed, conveyance, mortgage or lease thereof. All persons, corporations, partnerships, trusts, associations, or other legal entities who may occupy, use, enjoy or control a Lot or Lots or any part of the Real Estate in any manner shall be subject to the Declaration, the Articles of Incorporation, the Bylaws, and the rules and regulations applicable thereto as each may be amended or supplemented from time to time.

Section 2. Negligence. Each Owner shall be liable for the expense of any maintenance, repair or replacement rendered necessary by his negligence or by that of any member of his family or his or their guests, employees, agents or lessees to the extent that such expense is not covered by the proceeds of insurance carried by the Association. An Owner shall pay the amount of any increase in insurance premiums occasioned by his use, misuse, occupancy or abandonment of his Lot or its appurtenances or of the Common Area.

Section 3. Costs and Attorneys' Fees. In any proceeding arising because of failure of an Owner to make any payments required or to comply with any provision of this Declaration, the Articles of Incorporation, the Bylaws, or the rules and regulations adopted pursuant thereto as each may be amended from time to time, the Association shall be entitled to recover its reasonable attorneys' fees incurred in connection with such default or failure.

Section 4. Waiver. No Owner may exempt himself from liability for his contribution toward the Common Expenses by waiver of the use or enjoyment of any of the Common Area or by abandonment of his Lot.

Section 5. Severability Clause. The invalidity of any covenant, restriction, condition, limitation or other provision of this Declaration, the Articles or the Bylaws, shall not impair or affect in any manner the validity, enforceability or effect of the rest of this Declaration, the Articles, or the

Bylaws, and each shall be enforced to the greatest extent permitted by law.

Section 6. Pronouns. Any references to the masculine, feminine or neuter gender herein shall, unless the context clearly requires to the contrary, be deemed to refer to and include all genders. And the singular shall include and refer to the plural and vice versa as appropriate.

Section 7. Interpretation. The captions and titles of the various articles, sections or subsections of this Declaration are inserted herein for ease and convenience of reference only and shall not be used as an aid in interpreting or construing this Declaration or any provision hereof.

Section 8. Enforcement. The Association, any Owner, and the City of West Lafayette shall have the right to enforce, by any proceeding at law or in equity, all restrictions, conditions, covenants, reservations, liens and charges now or hereafter imposed by the provisions of this Declaration. The enforcing party shall be entitled to recovery of its costs and expenses of enforcement, including attorneys' fees, in any such enforcement action, provided that the Association or other enforcing party prevails in such action. Failure to enforce any covenant or restriction herein contained shall in no event be deemed a waiver of the right to do so thereafter.

IN WITNESS WHEREOF, the undersigned, being the Declarant herein, and being the owner of all Lots, has caused this Amended Declaration to be executed by Joseph A. Bonner, its President this 13th day of September, 1989.

LAFAYETTE BANK & TRUST COMPANY

By: Joseph A. Bonner
Joseph A. Bonner, President

ATTEST:

James C. Hilligoss
James C. Hilligoss
Vice President and
Assistant Secretary

STATE OF INDIANA)

) SS:

COUNTY OF TIPPECANOE)

Before me, the undersigned Notary Public, personally appeared Lafayette Bank & Trust Company, by Joseph A. Bonner, its President, and James C. Hilligoss, its Vice President and Assistant Secretary, who for and on behalf of said corporation acknowledged the execution of the foregoing Declaration and swore to the truth of the statements made therein.

Witness my hand and Notarial Seal this 13th day of September, 1989.

Melissa C. McCarty
Notary Public Melissa C. McCarty

My Commission Expires:

County of Residence:

12-8-89

Tippecanoe

This instrument prepared by:
STUART & BRANIGIN
By: Thomas R. McCully

EXHIBIT A
Legal Description of Real Estate

The North half of the Northwest Quarter of Section thirteen (13), Township Twenty-three (23) North, Range five (5) West, containing Eighty (80) acres, more or less.

Also, Lot 2 in Simmons Subdivision as recorded in Plat Book 14, Page 47, Slide A-53 in the Office of the Recorder, Tippecanoe County, Indiana, containing 0.92 acres, more or less.



CHICAGO TITLE

FIRST AMENDED DECLARATION
OF COVENANTS, CONDITIONS AND RESTRICTIONS
FOR BLACKBIRD FARMS PLANNED DEVELOPMENT

THIS FIRST AMENDED DECLARATION, made on the date hereinafter set forth by Lafayette Bank & Trust Company, an Indiana corporation, hereinafter referred to as "Declarant",

WITNESSETH:

WHEREAS, Declarant, was the owner of certain real estate in Wabash Township, Tippecanoe County, Indiana, which is more particularly described in the attached Exhibit A, which is incorporated herein by reference (the "Real Estate") executed a certain Declaration of Covenants, Conditions and Restrictions for Blackbird Farms Planned Development, and recorded said Declaration with the Tippecanoe County Recorder on February 2, 1990 as document number 90-01518;

WHEREAS, said Declaration grants Declarant the right to amend said Declaration, and Declarant now wishes to amend said Declaration in certain particulars and to restate all covenants, conditions and restrictions for Blackbird Farms Planned Development in this First Amended Declaration of Covenants, Conditions and Restrictions for Blackbird Farms Planned Development (hereinafter referred to as "Declaration").

NOW, THEREFORE, Declarant hereby declares that the Real Estate described above shall be held, sold and conveyed subject to the following easements, restrictions, covenants and conditions, which are for the purpose of protecting the value and desirability of, and which shall run with, the Real Estate and be binding on all parties having any right, title or interest in the Real Estate or any part thereof, their heirs, successors and assigns, and shall inure to the benefit of each Owner thereof.

ARTICLE I
DEFINITIONS

As used in this Declaration, the following terms shall have the following meanings, unless the context requires otherwise:

Section 1. "Articles" or "Articles of Incorporation" means the Articles of Incorporation of the Association. The Articles of Incorporation are incorporated herein by reference.

RECORDED IN RECORD

92-16830

®

4:10 O'CLOCK P M FEE 63.00

JUL 3 1 1992

Ruth E. Skedd

RECORDER TIPPECANOE CO., IN

CHICAGO TITLE

last
part

Section 2. "Association" means Blackbird Farms Homeowners Association, Inc., an Indiana not-for-profit corporation, its successors and assigns.

Section 3. "Blackbird Pond" means that body of water located in the Common Area, which is designed to handle the surface water drainage requirements of the Real Estate and is not to be construed to assure that water will be in the pond at all times or that any particular level of water will be contained therein.

Section 4. "Board of Directors" means the Board of Directors of the Association.

Section 5. "Bylaws" means the Bylaws of the Association. The Bylaws are incorporated herein by reference.

Section 6. "Common Area" means all of the area designated as Common Area and Limited Common Area on the recorded Final Detailed Plans of Blackbird Farms Planned Development, including Common Area Lots A, B, C and D and all other Common Area Lots shown on the Plans (as hereinafter defined), including but not limited to Blackbird Pond and embankment areas of Blackbird Pond, all landscaped areas, driveways, sidewalks, parking areas and recreational areas, if any, but excluding all Lots and dedicated streets. The Common Area shall be conveyed to the Association, and (except with respect to the Limited Common Area, use of which is limited as provided elsewhere herein) is to be held for the common use and enjoyment of the Owners subject to the provisions hereof.

Section 7. "Common Expense" means expenses for administration of the Association and expenses for the upkeep, maintenance, repair and replacement of the Common Area and all other sums lawfully assessed against the Members of the Association, provided, however, that no expenditure for improvements to the Common Area in addition to the improvements shown on the Plans shall be deemed to be a Common Expense.

Section 8. "Declarant" means Lafayette Bank & Trust Company, its successors and assigns.

Section 9. "Dwelling Unit" means one of the living units located upon a Lot.

Section 10. "Lot" means any plot of ground designated as such upon the recorded Final Plans of Blackbird Farms Planned Development or any part thereof and upon which any one (1) Dwelling Unit is constructed, is to be constructed or has existed. The term Lot shall be deemed to include the Dwelling Unit, if any, located thereon.

Section 11. "Member" means a member of the Association.

Section 12. "Mortgagee" means the holder of a first mortgage lien upon a Lot.

Section 13. "Owner" means a person, firm, corporation, partnership, association, trust or other legal entity, or any combination thereof, who owns fee simple title to a Lot.

Section 14. "Plans" means the recorded Final Detailed Plans of Blackbird Farms Planned Development.

Section 15. "Real Estate" means that certain real estate described in the attached Exhibit A.

Section 16. "Limited Common Area" means the driveway areas abutting certain Lots, which are designated as Limited Common Area on the Plans and which will not be dedicated to the City of West Lafayette. The Limited Common Area may be used only for driveway purposes and only by the Owners of the Lots abutting such Limited Common Area, and the families, guests, lessees and invitees of such Owners.

ARTICLE II

PROPERTY RIGHTS

Section 1. General Description of Property Rights. Every Owner of a Lot within the Real Estate will obtain fee simple ownership of said Lot and of the improvements constructed thereon. The Association will perform certain regular maintenance tasks on the Common Area within the Real Estate. Every Owner will be required to perform all other repairs, replacements and maintenance on that Owner's Lot and upon the Dwelling Unit located thereon, withstanding any provision herein to the contrary, the Association shall have the right to enter into agreements with Owners of Lots, providing for maintenance of all or part of the Common Area by such Owners of Lots in exchange for reduction or elimination of Regular Assessments otherwise payable to the Association by such Owners of Lots during the term of any such agreement.

Section 2. Ownership of Common Area. The Common Area shall be conveyed to or owned by the Association, and shall be held for the use and enjoyment of the Owners, all of which shall have the right and easement of enjoyment and in to the Common Area (except the Limited Common Area, use of which is limited as provided elsewhere herein), which right shall pass with title to every Lot, subject to the provisions of this Declaration, including but not limited to the following:

(a) The right of the Association to suspend any Member from the right to use recreational facilities, if any, for any period during which any assessment against such Member's Lot remains unpaid.

(b) The right of the Association, upon approval by vote of at least sixty-seven percent (67%) of the Members, to dedicate or transfer all or any part of the Common Area to any public agency, authority or utility for such Common Area purposes and upon such conditions as may be acceptable to the Association, provided that any such dedication or transfer shall be subject to acceptance thereof by the public agency.

(c) The right of the Association or its Board of Directors to adopt such rules and regulations regarding use of the Common Area and recreational facilities, if any, by the Members.

(d) The right of the Association, in accordance with the Articles of Incorporation and Bylaws, to borrow for purposes of repairs, maintenance and replacement of improvements upon the Common Area.

Section 3. Delegation of Use. Any Owner may delegate, in accordance with the Bylaws, his right of enjoyment to the Common Area and facilities to the members of his family, his tenants or contract purchasers who reside on any Lot.

Section 4. Certain Encroachments and Easements. If by reason of inexactness of construction, settling after construction or for any other reason, any Common Area or improvement upon any Common Area encroaches upon any other Lot, an easement shall be deemed to exist and run to the Association for the maintenance, use and enjoyment of such Common Area. Further, if for said reasons any Dwelling Unit located upon Lots 82-188 encroaches upon the adjoining Lot by not more than one (1) foot, an easement shall be deemed to exist from the Owner of the Lot upon which said Dwelling Unit encroaches to the Owner of the encroaching Dwelling Unit. Each Owner of Lots 82-188 shall have an easement over and across any adjoining Lot for purposes of construction, maintenance and repair of such Owner's Dwelling Unit, provided that the Owner engaging in such construction, maintenance or repair shall upon conclusion of such work restore the adjoining Lot to its condition prior to commencement thereof. Each Owner shall have an easement in common with each other Owner to use all pipes, wires, ducts, cables, conduits, utility lines and other common facilities, if any, located in the Common Area and serving such Owner's Dwelling Unit. Notwithstanding the foregoing, no utility shall place any

-4-

®

CHICAGO TITLE

improvements or utility structures in any location upon the Real Estate which would interfere with other improvement shown on the Plans.

Section 5. Easement for Utilities and Public and Quasi-Public Vehicles. All quasi-public vehicles including, but not limited to, police, fire and other emergency vehicles, trash and garbage collection, post-office vehicles and privately owned delivery vehicles shall have the right to enter upon the Common Area in the Real Estate in the performance of their duties. Notwithstanding the foregoing, garbage trucks, street cleaning and snow removal equipment of the City of West Lafayette will provide service only upon the dedicated streets in the Real Estate and will not enter any of the Common Area driveways. All water, sewer, gas, electric, telephone and cable television utilities are to be underground. Street lighting are to be provided as shown on the Plans. An easement is also granted to all utilities and their agents for ingress, egress, installation, replacement, repair and maintenance of such utilities, including but not limited to water, sewer, gas, telephone and electricity on the Real Estate; provided, however, nothing herein shall permit the installation of sewers, electric lines, water lines or other utilities except as initially designed and approved by Declarant on the Plans or as thereafter may be approved by Declarant or by the Board of Directors. By virtue of this easement all of the foregoing utility companies are expressly permitted to erect and maintain the necessary equipment on the Real Estate and to affix and maintain electrical and telephone wires, circuits and conduits on and under the roofs and exterior walls of Dwelling Units. If any utility furnishing service requests a specific easement by a separate recordable document, Declarant shall have the right to grant such easement upon the Real Estate without violating the terms hereof, provided that no such easement shall conflict with the Plans. The easements granted herein shall in no way affect any other recorded easement with respect to the Real Estate.

An easement is also granted to the Association, its officers, agents and employees and to any management company selected by the Association to enter upon or cross over any Lot or the Common Area to perform its duties.

ARTICLE III

ASSOCIATION MEMBERSHIP AND VOTING RIGHTS

Section 1. Membership. Every Owner of a Lot shall be a Member of the Association. Membership shall be appurtenant to each Lot and may not be separated from ownership of any Lot.

-5-



CHICAGO TITLE

Section 2. Classes of Membership. The Association shall have three classes of membership:

Class A: Class A Members shall be all Owners of Lots 1 through 188 except the Declarant, its successors and assigns. Ownership of one of said Lots shall be the sole qualification for Class A membership.

Class B: Class B Members shall be all Owners of Lots 189-191 except the Declarant, its successors and assigns. Ownership of one of said Lots shall be the sole qualification for Class B membership.

Class C: Class C Members shall be Declarant and its successors and assigns. Class C membership shall apply to any Lot owned by Declarant, its successors and assigns. Class C membership shall cease and be converted to Class A membership (as to Lots 1-188) or Class B membership (as to Lots 189-191) upon the first to occur of the following dates (hereinafter referred to as the "Applicable Date"):

(a) the date when the written resignation of the Class C Member(s) as such is delivered to the registered agent of the Association; or

(b) the date when the total votes outstanding in Class A membership equal or exceed the total votes outstanding in Class C membership; or

(c) August 9, 1999.

The Class C membership of Declarant or its successors or assigns with respect to any individual Lot shall cease and be converted to Class A or Class B membership, as the case may be, upon actual occupancy of the Dwelling Unit located upon that Lot by any person other than Declarant, its successor or assigns. The Class A membership or Class B membership of an Owner shall terminate when such person ceases to be the Owner of such Lot, and shall be transferred to the new Owner of such Lot.

Section 3. Voting Rights of Classes.

Class A: Class A Members shall be entitled to cast one vote for each of Lots 1-188 owned by such Members on all matters submitted to a vote of the Members, provided, however, that the votes of the Class A members as a group shall be counted as sixty-six percent (66%) of the total votes of the Members of the Association.

Class B: Class B Members shall be entitled to cast one vote for each of Lots 189-191 owned by such Members on all matters submitted to a vote of the Members, provided, however, that the votes of the Class B members as a group shall be counted as thirty-four percent (34%) of the total votes of the Members of the Association.

Class C: The Class C Member(s) shall be entitled to cast three votes for each Lot they own on all matters submitted to a vote of the membership. Said votes shall be counted as Class A votes for each of Lots 1-188 owned by Class C Members and shall be counted as Class B votes for each of Lots 189-191 owned by Class C Members.

When more than one person is an Owner of a Lot, all such persons shall be Members in the applicable Class, but their total vote shall not exceed one per Lot owned, and such vote shall be cast as one unit in such manner as the majority of the Owners of such Lot may agree. In the event such Owners fail to reach agreement, they shall not be entitled to vote and shall be considered as abstaining. In the event some of such Owners do not attend the meeting, in person or by proxy, those Owners who are in attendance, in person or by proxy, for purposes of determining the manner in which their vote shall be cast, shall be considered as the sole Owner of the Lot.

The Board of Directors may suspend the voting rights of a Member during any period in which such Member shall be in default in payment of any assessment levied by the Association.

Section 4. Functions. The Association has been formed for the purposes of providing for the maintenance, repair, upkeep, replacement, administration, operation and ownership of the Common Area, the enforcement of the covenants contained herein, the payment of taxes assessed against the Common Area, the payment of charges for utility service to the Common Area (including electricity for street lighting), and any other necessary expenses and costs in connection with the Common Area, except as otherwise limited hereby, and the performance of such other functions as may be designated to it to be performed under this Declaration. The Association also shall have the authority to enter into a recreational facilities lease with the owner of any recreational facilities located within the Real Estate, and to make those recreational facilities available to Owners upon such terms as are established by the Board of Directors. withstanding any provision herein to the contrary, the Association shall have the right to enter into agreements with Owners of Lots, providing for maintenance of all or part of the Common Area by such Owners of Lots in exchange for reduction or elimination of Regular Assessments otherwise payable to the Association by such Owners of Lots during the term of any such agreement.

Section 5. Board of Directors. The powers, limitations on powers, compensation, duties, qualifications, terms of office, method of election, method of removal and other provisions concerning the Board of Directors are as set forth in the Articles of Incorporation and the Bylaws. The Board of Directors shall be elected annually by the Members of the Association, in accordance with the procedures set forth in the Bylaws.

ARTICLE IV

COVENANT FOR MAINTENANCE ASSESSMENTS

Section 1. Purpose of Assessments. Maintenance, repairs, replacements and upkeep of the Common Area, including without limitation Blackbird Pond and all other drainage facilities upon the Real Estate, shall be provided by the Association as part of its duties, and the cost thereof shall constitute part of the Common Expense. Each Owner shall be responsible for maintaining and keeping such Owner's Lot and all improvements thereon in a good, clean and sanitary condition at such Owner's expense. Withstanding any provision herein to the contrary, the Association shall have the right to enter into agreements with Owners of Lots, providing for maintenance of all or part of the Common Area by such Owners of Lots in exchange for reduction or elimination of Regular Assessments otherwise payable to the Association by such Owners of Lots during the term of any such agreement.

Notwithstanding any obligation or duty of the Association to repair or maintain the Common Area, if due to the willful, intentional or negligent acts or omissions of Owner or of a member of such Owner's family or a guest, tenant, invitee or other occupant or visitor of such Owner, damage shall be caused to the Common Area, or if maintenance, repairs or replacements shall be required thereby which would otherwise be a Common Expense, then such Owner shall pay for such damage and such maintenance, repairs and replacements as may be determined by the Association unless such loss is covered by an insurance policy owned by the Association which contains a waiver of subrogation clause. If not paid by such Owner upon demand by the Association, the cost of repairing such damage shall be added to and become part of the assessment to which such Owner's Lot is subject.

If any Owner shall fail to maintain and keep such Owner's Lot or any part thereof in a good, clean and sanitary condition, exclusive of maintenance of the Dwelling Unit, the Association may perform any work necessary to do so and charge the Owner of such Lot for such cost, which cost shall be added to and become a part of the assessment to which such Owner's Lot is subject.



CHICAGO TITLE

The assessments levied by the Association shall be used exclusively to promote the recreation, health, safety and welfare of the residents in the Real Estate and for the costs and expenses incident to operation of the Association, including without limitation snow removal for the Common Area, repair and replacement of improvements on the Common Area, and for payment of other Common Expenses as defined in the Bylaws. Any fee charged to Owners by the Association for use of recreational facilities leased by the Association, if any, shall be deemed to be a part of the Regular Assessment (as hereinafter defined).

No expenditure for improvements to the Common Area in addition to the improvements shown on the Plans shall be deemed to be a Common Expense, and no assessment (other than a Special Assessment as hereinafter defined) shall be used to pay any expenditures for such additional improvements.

Section 2. Annual Accounting. Annually, after the close of each fiscal year of the Association and prior to the date of the annual meeting of the Association next following the end of such fiscal year, the Board of Directors shall cause to be prepared and furnished to each Owner a financial statement prepared by a certified public accountant or firm of certified public accountants then servicing the Association, which statement shall show all receipts and expenses received, incurred and paid by the Association during the preceding fiscal year.

Section 3. Proposed Annual Budget. Annually, before the date of the annual meeting of the Association, the Board of Directors shall cause to be prepared a proposed annual budget for the current fiscal year estimating the total amount of the Common Expenses for the current fiscal year and shall furnish a copy of such proposed budget to each Owner at or prior to the time the notice of such annual meeting is mailed or delivered to such Owners. The annual budget shall be submitted to the Owners at the annual meeting of the Association for adoption, and, if so adopted, shall be the basis for the Regular Assessments (as hereinafter defined) for the current fiscal year. At the annual meeting of the Owners, the budget may be approved in a whole or in part or may be amended in whole or in part by a majority vote of the Owners; provided, however, that in no event shall the annual meeting of the Owners be adjourned until an annual budget is approved and adopted at such meeting, either the proposed annual budget or the proposed annual budget as amended. The annual budget, the Regular Assessments and all sums assessed by the Association shall be established by using generally accepted accounting principles applied on a consistent basis.

The annual budget may include the establishment and maintenance of a replacement reserve fund for replacement and repair of the Common Area, which replacement reserve fund (if established) shall be used for those purposes and not for usual and ordinary repair expenses. Such replacement reserve fund for replacement and repair of the Common Area shall be maintained by the Association in a separate interest bearing account or accounts with one or more banks or savings and loan associations authorized to conduct business in Tippecanoe County, Indiana selected from time to time by the Board of Directors.

The failure or delay of the Board of Directors to prepare a proposed annual budget and to furnish a copy thereof to the Owners shall not constitute a waiver or release in any manner of the obligations of the Owners to pay the Common Expenses as herein provided, whenever determined. Whenever, whether before or after the annual meeting of the Association, there is no annual budget approved by the Owners as herein provided for such current fiscal year, the Owners shall continue to pay Regular Assessments based upon the last approved budget or, at the option of the Board of Directors, based upon one hundred and ten percent (110%) of such last approved budget, as a temporary budget.

Section 4. Regular Assessments. The annual budget as adopted by the Owners shall, based on the estimated cash requirement for the common Expenses in the fiscal year as set forth in said budget, contain a proposed assessment against each Lot. Sixty-six percent (66%) of the total amount of any Regular Assessment or Special Assessment (as hereinafter defined) shall be assessed against Lots 1-188, and thirty-four percent (34%) thereof shall be assessed against Lots 189-191. The amount assessed against Lots 1-188 shall be divided equally among said Lots, and the amount assessed against Lots 189-191 shall be divided equally among said Lots. Immediately following the adoption of the annual budget, each Owner shall be given written notice of such assessment against his respective Lot (herein called the "Regular Assessment"). In the event the Regular Assessment for a particular fiscal year is initially based upon a temporary budget, such Regular Assessment shall be revised, within fifteen (15) days following adoption of the final annual budget by the Owners, to reflect the assessment against each Lot based upon such annual budget as finally adopted by the Owners. The aggregate amount of the Regular Assessments shall be equal to the total amount of expenses provided and included in the final annual budget, including any reserve funds as hereinabove provided. The Regular Assessment against each Lot shall be paid in advance in one annual installment, payable in advance on or before the first day of each fiscal year of the Association. Payment of the Regular Assessment shall be made to the Board of Directors or any Managing Agent, as directed by the Board of

Directors. In the event the Regular Assessment for a particular fiscal year of the Association was initially based upon a temporary budget:

- (i) if the Regular Assessment based upon the final annual budget adopted by the Owners exceeds the amount of the Regular Assessment based upon the temporary budget, such excess shall be payable on or before the first day of the second month following the determination of the Regular Assessment based upon the annual budget finally adopted by the Owners, or
- (ii) if the Regular Assessment based upon the temporary budget exceeds the Regular Assessment based upon the final annual budget adopted by the Owners, such excess shall be refunded to the Owner on or before the first day of the second month following the determination of the Regular Assessment based upon the annual budget finally adopted by the Owners.

The Regular Assessment for the current fiscal year of the Association shall become a lien on each Lot as of the first day of each fiscal year of the Association, even though the final determination of the amount of such Regular Assessment may not have been made by that date. The fact that an Owner has paid his Regular Assessment for the current fiscal year in whole or in part based upon a temporary budget and thereafter, before the annual budget and Regular Assessment are finally determined, approved and adjusted as herein provided, sells, conveys or transfers his Lot or any interest therein, shall not relieve or release such Owner or his successor as Owner of such Lot from payment of the Regular Assessment for such Lot as finally determined, and such Owner and his successor as Owner of such Lot shall be jointly and severally liable for the Regular Assessment as finally determined. Any statement of unpaid assessments furnished by the Association pursuant hereto prior to the final determination and adoption of the annual budget and Regular Assessment for the year in which such statement is made shall state that the matters set forth therein are subject to adjustment upon determination and adoption of the final budget and Regular Assessment for such year, and all parties to who any such statement may be delivered or who may rely thereon shall be bound by such final determinations. Regular Assessments shall be due and payable automatically on their respective due dates without any notice from the Board of Directors or the Association, and neither the Board of Directors nor the Association shall be responsible for providing any notice or statements to Owners for the same. Notwithstanding any provision herein or in the Articles or Bylaws to the contrary, the Association shall have the right to enter into agreements with Owners of Lots, providing for maintenance of all or part of the

Common Area by such Owners of Lots in exchange for reduction or elimination of Regular Assessments otherwise payable to the Association by such Owners of Lots during the term of any such agreement.

Section 5. Special Assessments. From time to time Common Expenses of an unusual or extraordinary nature or not otherwise anticipated may arise. At such time and provided that any such assessment shall have the assent of sixty-seven percent (67%) of all Members who are voting in person or by proxy at a meeting duly called for this purpose. The Board of Directors shall have the full right, power and authority to make special assessments which, upon resolution of the Board of Directors, shall become a lien on each Lot, divided among Lots in the same manner as is set forth above with respect to Regular Assessments (hereinafter referred to as "Special Assessment"). Without limiting the generality of the foregoing provisions, Special Assessments may be made by the Board of Directors from time to time to pay for capital expenditures and to pay for the cost of any repair or reconstruction of damage caused by fire or other casualty or disaster to the extent insurance proceeds are insufficient therefor under the circumstances described in this Declaration.

Section 6. Regular Assessments Prior to the Applicable Date. During the period that Dwelling Units are being constructed within the Real Estate, it is difficult to accurately allocate the Common Expenses to the individual Lots. The purpose of this Section is to provide the method of the payment of the Common Expenses during the period prior to the Applicable Date to enable the Association to perform its duties and functions. Accordingly, and notwithstanding any other provision contained in the Declaration, the Articles or the Bylaws or otherwise, prior to the Applicable Date, the annual budget and all Regular Assessments and Special Assessments shall be established by the Initial Board of Directors without any meeting or concurrence of the Owners; provided, however, the Regular Assessments shall be determined in accordance with the provisions contained in this Section.

The Association will enter into a management agreement with Declarant (or a corporation or other entity designated by Declarant) (hereinafter referred to as "Management Agent" or "Managing Agent") in accordance with the provisions of this Declaration. So long as such management agreement (or any similar agreement) remains in effect, the Common Expenses and Regular Assessments shall be paid by Owners to Management Agent. Declarant agrees that until the earlier of (1) the termination of said management agreement or (2) 1 year after the date of execution thereof, the Regular Assessment shall not exceed Three Hundred Dollars (\$300) per year (the "Guaranteed Charge"). After

this date (assuming that said management agreement or similar agreement is still in effect) and so long thereafter as said management agreement (or similar agreement) remains in effect and the Management Agent continues to perform such functions, Declarant guarantees that the Regular Assessment shall not exceed the amount of the Guaranteed Charge plus a maximum of a ten percent (10%) increase in the Guaranteed charge for each year. Such adjustments to the Guaranteed Charge (up to a ten percent (10%) annual increase as determined by the Board of Directors) shall be made annually on January 1 of each year so long as said management agreement remains in effect and the Management Agent continues to perform such functions. Payment of such charge shall during such guaranteed period entirely defray the Owner's entire obligation for his share of Common Expenses and shall be the Owner's entire Regular Assessment. Declarant shall be responsible for any deficit during such guarantee period; provided, however, that this guarantee is not intended to include, and does not include, major physical alterations or other capital expenditures not ordinarily anticipated in normal maintenance operations. Such expenditures, if any, must be covered through Special Assessments.

That portion of the Regular Assessment collected by Declarant prior to the Applicable Date applicable to any replacement reserve created shall be held by the initial Board of Directors and if required, applied to the replacement of Common Areas. To the extent that any such replacement reserve is not so applied, the balance thereof shall be retained by the Association at the Applicable Date.

Payment of Regular Assessment prior to the Applicable Date with respect to each Lot not owned by Declarant shall commence on the date of conveyance by Declarant to such new Owner. The first payment shall be payable on the date of conveyance, with the amount thereof prorated to said date of conveyance. Thereafter, payment of the Regular Assessment shall be paid the first day of each fiscal year during the period prior to the Applicable Date, withstanding any provision herein to the contrary, (a) Declarant shall not be responsible for regular assessments or special assessments for Lots owned by Declarant, by W.H. Long Builders, Inc. or by Gunstra Builders, Inc. and not occupied, other than by said entities, so long as the Class C membership is in existence, and (b) the Association shall have the right to enter into agreements with Owners of Lots, providing for maintenance of all or part of the Common Area by such Owners of Lots in exchange for reduction or elimination of Regular Assessments otherwise payable to the Association by such Owners of Lots during the term of any such agreement.



Each Owner hereby authorizes the Association and the Board of Directors and its officers to enter into the management agreement described in this Declaration and to adhere to and abide by the same.

Section 7. Failure of Owner to Pay Assessments. No Owner may exempt himself from paying Regular Assessments and Special Assessments or from contributing toward the Common Expense or toward any other expense lawfully agreed upon by waiver of the use or enjoyment of the Common Area or by abandonment of the Lot belonging to him. Each Owner shall be personally liable for the payment of all Regular and Special Assessments. Where the Owner constitutes more than one person the liability of such persons shall be joint and several. If any Owner shall fail, refuse or neglect to make any payment of any Regular Assessment or Special Assessment when due, the lien for such assessment on the Owner's Lot and Dwelling Unit may be filed and foreclosed by the Board of Directors for and on behalf of the Association as a mortgage on real property or as otherwise provided by law. Upon the failure of the Owner to make timely payments of any Regular Assessment or Special Assessment when due the Board of Directors may in its discretion accelerate the entire balance of unpaid assessments for the current fiscal year and the Owner and any occupant of the Lot and Dwelling Unit shall be jointly and severally liable for the payment to the Association and the Board of Directors shall be entitled to the appointment of a receiver for the purpose of preserving the Lot and Dwelling Unit and to collect the rentals and other profits therefrom for the benefit of the Association to be applied to the unpaid Regular Assessments or Special Assessments. The Board of Directors may at its option bring suit to recover a money judgment for any unpaid Regular Assessment or Special Assessment without foreclosing or waiving the lien securing the same. Any action to recover a Regular Assessment or Special Assessment whether by foreclosure or otherwise the Board of Directors for and on behalf of the Association shall be entitled to recover from the Owner of the respective Lot and Dwelling Unit costs and expenses of such action incurred (including but not limited to reasonable attorneys fees) and interest from the date such assessments were due until paid at the rate equal to the prime interest rate then being charged by Lafayette Bank & Trust Company, Lafayette, Indiana its largest and best corporate customer (or if said bank is no longer in existence then such rate charged by another national bank in Tippecanoe County, Indiana selected by the Board of Directors).

Section 8. Subordination of Assessment Lien to Mortgage. Notwithstanding anything contained in this Declaration, the Articles or the Bylaws, any sale or transfer of a lot to a Mortgagee pursuant to a foreclosure on its mortgage or conveyance in lieu thereof, or a conveyance to any person at a public sale



CHICAGO TITLE

in a manner provided by law with respect to mortgage foreclosure shall extinguish the lien of any unpaid installment of any Regular Assessment of Special Assessment as to such installment which became due prior to such sale, transfer or conveyance; provided, however, that the extinguishment of such lien cannot relieve the prior Owner from personal liability therefor. No such sale, transfer or conveyance shall relieve the Lot and Dwelling Unit or the purchaser at such foreclosure sale or grantee in the event of conveyance in lieu thereof, from liability for any installments of Regular Assessments or Special Assessments thereafter becoming due or from the lien therefor. Such unpaid share of any Regular Assessments or Special Assessments, the lien for which has been divested as aforesaid shall be deemed to be a Common Expense collectible from all Owners (including the party acquiring the subject Lot from which it arose).

ARTICLE V

COVENANTS AND RESTRICTIONS

The following covenants and restrictions on the use and enjoyment of the Lots, Dwelling Units and Common Area shall be in addition to any other covenants or restrictions contained herein and in the Final Plans, and all such covenants and restrictions are for the mutual benefit and protection of the present and future Owners and shall run with the land and inure to the benefit of and be enforceable by any Owner, or by the Association. Any conflict between this Declaration and the Plans shall be controlled by the Plans. Present or future Owners or the Association shall be entitled to injunctive relief against any violation or attempted violation of any such covenants and restrictions, and shall, in addition, be entitled to damages for any injuries or losses resulting from any violations thereof, but there shall be no right of reversion or forfeiture resulting from such violation. These covenants and restrictions are as follows:

Section 1. Subject to U.S. Postal Regulations, the Declarant reserves the right to approve the type of mailboxes installed on the Real Estate.

Section 2. All Lots and Dwelling Units shall be used exclusively for residential purposes and for occupancy by a single family, except the Lots 189-191, which shall be used for multi-family apartment buildings. Except as hereinafter provided, no structure shall be erected or placed on any of Lots 1-188 other than one single-family dwelling and a private garage for two or three vehicles. The total living area of a one-story Dwelling Unit on Lots 1-81 shall be not less than 1400 square

feet and the total living area of a two-story dwelling house on Lots 1-81 shall be not less than 1800 square feet. The total living area of a one-story Dwelling Unit on Lots 82-188 shall be not less than 1350 square feet and the total living area of a two-story dwelling house on Lots 82-188 shall be not less than 1500 square feet. The foregoing square footage minimums are exclusive, in all cases, of porches, decks, patios, garages and similar areas not regarded as living areas.

The total foundation area (including garage) of a Dwelling Unit on Lots 1-81 shall be not greater than thirty percent (30%) of the total foundation area of the Lot upon which such Dwelling Unit is constructed. The total foundation area (including garage) of a Dwelling Unit on Lots 82-188 shall be not greater than forty percent (40%) of the total foundation area of the Lot upon which such Dwelling Unit is constructed.

Each Dwelling Unit on Lots 1-188 shall have a garage capable of housing two or three automobiles. Other structures which are consistent with the high-quality residential character of the neighborhood may be erected or placed on Lots only with the express written approval of the Architectural Review Board as hereinafter described. No changes in the exterior dimensions of Dwelling Units located on Lots 82-188 shall be made without approval of the Architectural Review Board.

On Lots 82-188, Dwelling Units may be constructed shall be constructed nearer than twelve (12) feet from the Lot line opposite the Lot line used as a "zero lot line"

Section 3. Real estate taxes are to be separately assessed and taxed to each Lot. Any real estate taxes or other assessments which are chargeable against the Common Area shall be paid by the Association and treated as a Common Expense.

Section 4. Each Owner shall pay for his own utilities which are separately metered. Utilities which are not separately metered, if any, shall be treated as and paid as part of the Common Expense unless otherwise determined by the Association.

Section 5. All driveways shall be of concrete or blacktop construction and shall be built no later than thirty (30) days after a new dwelling is occupied, weather permitting.

Section 6. No permanent outside clothesline shall be erected, placed or allowed to remain on the Real Estate.

Section 7. No Owner shall permit anything to be done or kept in his Dwelling Unit or on his Lot or on any of the Common Area which will result in a cancellation of insurance or increase

in insurance on any part of the Common Area, or which would be in violation of any law or ordinance or the requirements of any insurance underwriting or rating bureau.

Section 8. No nuisance shall be permitted and no waste shall be committed in any Dwelling Unit, the Common Area or on any Lot. The Board of Directors determination as to what is a nuisance shall be conclusive.

Section 9. No Owner shall cause or permit anything to be hung or displayed on the outside of the windows of his Dwelling Unit or placed on the outside walls of any building, and no sign, awning, canopy or radio or television antenna or other attachment or thing shall be affixed to or placed upon the exterior walls or roofs or any other parts of any building without the prior written consent of the Architectural Review Board.

Section 10. No animals, livestock or poultry of any kind shall be raised, bred or kept in any Dwelling Unit or on any Lot or any of the Common Area, except that pet dogs, cats or customary household pets may be kept in a Dwelling Unit, provided that such pet is not kept, bred or maintained for any commercial purpose, and does not create a nuisance. Pets shall be taken outdoors only under leash or other restraint and while attended by its owner and an Owner shall be fully liable for any injury or damage to persons or property, including the Common Area caused by his pet. The Board of Directors may adopt such other rules and regulations regarding pets as it may deem necessary from time to time. Any pet which, in the judgment of the Board of Directors, is causing or creating a nuisance or unreasonable disturbance or noise, shall be permanently removed from the Real Estate within ten (10) days after written notice from the Board of Directors to the respective Owner to do so.

Section 11. The common Area shall be kept free and clear of rubbish, debris and other unsightly materials.

Section 12. Except for management of the affairs of the Association, no industry, business, trade, occupation or profession of any kind shall be conducted, maintained or permitted on the Real Estate; provided, however, this restriction shall not be construed to prevent an Owner from (a) maintaining his professional library therein; (b) keeping his personal, business or professional records or accounts therein; or (c) handling his personal business or professional telephone calls or correspondence therein. Such uses are expressly declared customarily incident to the principal residential use and not in violation of any restrictions under this Section.

Section 13. "For sale," "For rent" or "for lease" signs may be displayed upon the Real Estate only for reasonable periods and only upon the Lot to which such sign relates. No other sign or other window or advertising display shall be maintained or permitted on any part of the Real Estate, any Lot or any dwelling Unit without the prior consent of the Board of Directors; provided, however, that the right is reserved by the Declarant and the board to place or allow to be placed "for sale" or "for lease" and other signs on or about the Real Estate in connection with any unsold or unoccupied Lots and Dwelling Units.

Section 14. All Owners and members of their families, their guests, or invitees, and all occupants of any Dwelling Unit or other persons entitled to use the same and to use and enjoy the Common Area or any part thereof, shall observe and be governed by such rules and regulations as may from time to time be promulgated and issued by the Board of Directors governing the operation, use and enjoyment of the Common Area.

Section 15. No repair work shall be done on the Real Estate on any vehicles, including passenger automobiles. No truck of any kind that requires a "truck license", no boat or trailer and no unlicensed vehicle shall be parked or permitted to remain on any Lot or any Common Area unless the same is enclosed by a garage and not exposed to view. Trucks making deliveries or present in connection with service, repair or construction within the Real Estate are excepted. Other vehicles of any kind except conventional passenger cars shall not be parked or permitted to remain on any Lot or any Common Area for a period in excess of forty-eight (48) hours unless enclosed by a garage and not exposed to view. The purpose of this restriction is to preserve the overall appearance and integrity of the neighborhood. The parking restrictions set forth herein may be altered, amended or supplemented by the Board of Directors, provided that all such alterations, amendments and supplements shall be designed to achieve the purposes set forth in the preceding sentence.

Section 16. No Owner shall be allowed to plant trees, landscape or do any gardening in any of the Common Area, except with express permission from the Board of Directors. withstanding any provision herein to the contrary, the Association shall have the right to enter into agreements with Owners of Lots, providing for maintenance of all or part of the Common Area by such Owners of Lots in exchange for reduction or elimination of Regular Assessments otherwise payable to the Association by such Owners of Lots during the term of any such agreement.

Section 17. The Common Area shall be used and enjoyed only for the purposes for which it is designed and intended, and shall be used subject to the rules and regulations from time to time adopted by the Board of Directors.

Section 18. No boats shall be permitted on the Lake.

Section 19. No swimming shall be permitted in the Lake.

Section 20. No Owner may rent or lease his Dwelling Unit for transient or hotel purposes.

Section 21. No noxious or offensive trade or activity shall be carried on upon any of the Real Estate, nor shall anything be done thereon which may be or become an annoyance or nuisance to the neighborhood. No property shall be used or maintained as a dumping ground for rubbish. Trash, garbage or other waste shall be kept in sanitary containers. All equipment for the storage or disposal of such material shall be kept in a clean and sanitary condition and out of view of other Lots and the street, except that garbage containers may be placed within view for the purpose of garbage pick-up.

Section 22. Any Owner who leases a Dwelling Unit shall lease the entire Dwelling Unit and shall have a written lease which shall provide that the lease is subject to the provisions of the Declaration and any failure of the lessee to comply with the terms of the Declaration, shall be a default under the lease. A copy of each such lease shall be provided to the Association.

Section 23. The Board of Directors from time to time may promulgate further rules and regulations concerning the use of Lots and the Common Area. Copies of rules and regulations shall be furnished by the Board of Directors to the Owners prior to the time when they shall be effective.

Section 24. No access easements are hereby reserved as shown on the Plans. Along these lines, no vehicular access shall be permitted to or from the adjoining streets. This restriction may be enforced by the Tippecanoe County Area Plan Commission and shall be irrevocable except with the prior approval of the Tippecanoe County Area Planning Commission.

Section 25. Lots 25-28, 34-36 and 38-44 in the Real Estate are subject to a reservation of a forty (40) foot wide strip of land along the eastern boundary of said Lots as shown on the Plans, for street right-of-way purposes. No structures may be placed within the reserved area of said Lots. If within five (5) years after the date of recordation of the Plans said reserved

area has neither been acquired by a public body or agency nor have condemnation proceedings been commenced against said reserved area, the reserved designation shall be deemed removed from said reserved area without further action by Declarant or any other party. Owners of the reserved area shall be responsible for maintenance thereof.

Section 26. No Dwelling Unit shall be located nearer to the Lot line of any Lot in the Real Estate than the building setback lines shown on the Plans, provided that the following additional restriction shall apply to Lots 1-81: any garage constructed upon any corner Lot and having a vehicular access door facing the side street shall be located no nearer than twenty (20) feet from the side Lot line.

Notwithstanding anything to the contrary contained herein or in the Articles or Bylaws, including, but not limited to, any covenants and restrictions set forth herein or otherwise, Declarant shall have the right to use and maintain any Lots and Dwelling Units owned by Declarant and other portions of the Real Estate (other than individual Dwelling Units and Lots owned by Persons other than Declarant), all of each number and size and at such locations as Declarant in its sole discretion may determine, as Declarant may deem advisable or necessary in its sole discretion to aid in the construction of Dwelling Units and the sale of Lots and Dwelling Units or for the conducting of any business or activity attendant thereto, including, but not limited to, model Dwelling Units, storage areas, construction yards, signs, construction offices, sales offices, management offices and business offices. Declarant shall have the right to relocate any or all of the same from time to time as it desires. At no time shall any of such facilities so used or maintained by Declarant be or become part of the Common Area, unless so designated by Declarant, and Declarant shall have the right to remove the same from the Real Estate at any time. Notwithstanding the foregoing, Declarant's use of the Real Estate as provided above shall be limited to uses directly related to sale of Lots in the Real Estate, and development, construction and management of the Real Estate.

ARTICLE VI
AMENDMENT OF DECLARATION

Section 1. Generally. Except as otherwise provided in this Declaration, amendments to this Declaration shall be proposed and adopted in the following manner:



CHICAGO TITLE

- (i) Notice. Notice of the subject matter of any proposed amendment shall be included in the notice of the meeting at which the proposed amendment is to be considered.
- (ii) Resolution. A resolution to adopt a proposed amendment may be proposed by the Board of Directors or by Owners having in the aggregate at least a majority of the votes of all Owners.
- (iii) Meeting. The resolution concerning a proposed amendment must be adopted by the designated vote at a meeting duly called and held in accordance with the provisions of the Bylaws.
- (iv) Adoption. Any proposed amendment to this Declaration must be approved by a vote of not less than seventy-five percent (75%) in the aggregate of the votes of all Owners.
- (v) Special Amendments. No amendment to this Declaration shall be adopted which changes (1) the applicable share of an Owner's liability for the Common Expenses, or the method of determining the same, or (2) the provision of this Declaration with respect to casualty insurance or fidelity bonds to be maintained by the Association, or (3) the provisions of this Declaration with respect to reconstruction or repair of the Common Area in the event of Fire or any other casualty or disaster, or (4) the provisions of this Declaration establishing the Architectural Review Board and providing for its functions, or (5) the provisions of this Declaration with respect to the commencement of assessments on any Lot, without, in each and any of such circumstances, the unanimous approval of all Owners.
- (vi) Additional Special Amendments. No amendment to this Declaration shall be adopted which imposes a right to first refusal or similar restriction or which changes (1) the method of voting, or (2) reserves for and responsibility for maintenance, repair and replacement of the Common Area, or (3) annexation of property to the Real Estate, or (4) the leasing of Dwelling Units, or (5) termination of the applicability of this Declaration, without the consent of at least ninety percent (90%) of the votes of the Owners for the first twenty (20) years after recording of this Declaration and thereafter at least seventy-five percent (75%) of the votes of Owners.

(vii) **Recording.** Each amendment to the Declaration shall be executed by the President and Secretary of the Association and shall be recorded in the office of the Recorder of Tippecanoe County, Indiana, and such amendment shall not become effective until so recorded.

Section 2. Amendments by Declarant Only. Notwithstanding the foregoing or anything elsewhere contained herein or in any other documents, the Declarant shall have and hereby reserves the right and power acting alone and without the consent or approval of the Owners, the Association, the Board of Directors, any Mortgagee or any other person to amend or supplement this Declaration at any time and from time to time if such amendment or supplement is made (a) to comply with requirements of the Federal National Mortgage Association, the Government National Mortgage Association, the Federal Home Loan Mortgage Corporation, the Department of Housing and Urban Development, or any other governmental agency or any other public, quasi-public or private entity which performs (or may in the future perform) functions similar to those currently performed by such entities, (b) to induce any of such agencies or entities to make, purchase, sell, insure or guarantee first mortgages covering lots and Dwelling Units, (c) to bring this declaration into compliance with any requirements of applicable statutes, regulations or ordinances or (d) to correct clerical or typographical errors in this Declaration or any Exhibit hereto or any supplement or amendment thereto or (e) for any other reason. In furtherance of the foregoing, a power coupled with an interest is hereby reserved and granted to the Declarant to vote in favor of, make, or consent to any such amendments on behalf of each Owner as proxy or attorney-in-fact, as the case may be. Each deed, mortgage, trust deed, other evidence of obligation, or other instrument affecting a Lot or Dwelling Unit and the acceptance thereof shall be deemed to be a grant and acknowledgment of, and a consent to the reservation of, the power to the Declarant to vote in favor of, make, execute and record any such amendments. The right of the Declarant to act pursuant to rights reserved or granted under this Section shall terminate at such time as the Declarant no longer hold or controls title to any part or portion of the Real Estate.

Section 3. Amendment Prior to the Applicable Date. Notwithstanding anything to the contrary contained herein, there shall be no amendment of the Declaration prior to the Applicable Date without the consent and approval of Declarant.

Section 4. Approval of Amendments. Notwithstanding anything to the contrary contained herein, there shall be no amendment of the Declaration with respect to project design.



CHICAGO TITLE

including the placement or nature of buildings, roadways, utilities or landscaping, without the prior approval of the Tippecanoe County Area Planning Commission.

ARTICLE VII

ARCHITECTURAL CONTROL

Section 1. Architectural Control.

(a) The Architectural Review Board. as a standing committee of the Association, there shall be, and hereby is, established an Architectural Review Board consisting of three (3) or more persons as may, from time to time, be provided in the Bylaws. Until the Applicable Date, the Architectural Review Board shall be the Initial Board of Directors. After the Applicable Date, the Architectural Review Board shall be appointed by the Board of Directors.

(b) Purposes. The Architectural Review Board shall regulate the external design, appearance, use and location of improvements on the Real Estate in such manner as to preserve and enhance values and to maintain a harmonious relationship among structures, improvements and the natural vegetation and topography.

(c) Conditions. No improvements, alterations, repairs, excavation, changes in grade or other work which in any way alters the exterior of any Lot or the improvements located thereon from its natural or improved state existing on the date such Lot was first conveyed in fee by the Declarant to an Owner shall be made or done without the prior approval of the Architectural Review Board, except as otherwise expressly provided in this Declaration. No building, fence, wall, Dwelling Unit, or other structure shall be commenced, erected, maintained, improved, altered, made or done on any Lot without the prior written approval of the Architectural Review Board.

(d) Procedures. In the event the Architectural Review Board fails to approve, modify or disapprove in writing an application within thirty (30) days after such application (and all plans, drawings, specifications and other items required to be submitted to it in accordance with such rules as it may adopt) have been given to it, approval will be deemed granted by the Architectural Review Board. A decision of the Architectural Review Board may be appealed to the Board of Directors which may reverse or modify such decision by a two-thirds (2/3) vote of the Directors then serving. The Architectural Review Board may establish committees consisting of two (2) or more of its



CHICAGO TITLE

members, which committees shall exercise such powers of the board as may be delegated to them.

(e) Maintenance of Architectural Control. The Association may not waive or abandon the procedure for regulating and enforcing the architectural design of the Dwelling Units nor for maintaining the Common Area (including the upkeep of common fences, driveways, lawns and plantings) without the prior written approval of all Owners.

ARTICLE VIII

INSURANCE

Section 1. Public Liability Insurance. The Association shall also purchase a master comprehensive public liability insurance policy in such amount or amounts as the Board of Directors shall deem appropriate from time to time but not less than \$1,000,000 for bodily injury, including deaths of persons and property damage arising out of a single occurrence. Such comprehensive public liability insurance policy shall cover the Association, the Board of Directors, any committee or organ of the Association or Board of Directors, any Managing Agent appointed or employed by the Association, all persons acting or who may come to act as agents or employees of any of the foregoing with respect to the Real Estate, all Owners of Lots and all other persons entitled to occupy any Lot or Dwelling Unit. Such public liability insurance policy shall contain a "sever-ability of interest" clause or endorsement which shall preclude the insurer from denying the claim of an Owner because of negligent acts of the Association or other Owners. Such public liability insurance policy shall contain a provision that such policy shall not be cancelled or substantially modified without at least ten (10) days written notice to the Association.

Section 2. Other Insurance. The Association shall also obtain any other insurance required by law to be maintained, including but not limited to workmen's compensation and occupational disease insurance, and such other insurance as the Board of Directors shall from time to time deem necessary, advisable or appropriate, including, but not limited to, liability insurance on vehicles owned or lease by the corporation and officers' and directors' liability policies. Such insurance coverage shall also provide for and cover cross liability claims of one insured party against another insured party. Such insurance shall inure to the benefit of each Owner, the Association, the Board of Directors and any Managing Agent acting on behalf of the Association. Each Owner shall be deemed to have delegated to the Board of Directors his right to adjust with the insurance

-24-

®

CHICAGO TITLE

companies all losses under the policies purchased by the Board of Directors policies purchased by the Board of Directors the proceeds of which are payable to the Board of Directors or the Association.

Section 3. General Provisions. The premiums for all insurance hereinabove described shall be paid by the Association as part of the Common Expenses. When any such policy of insurance hereinabove described has been obtained by or on behalf of the Association, written notice of the obtainment thereof and of any subsequent changes therein or termination thereof shall be promptly furnished to each Owner, which notice shall be furnished by the officer of the Association who is required to send notices of meetings of the Association. Under no circumstances shall any distribution of insurance proceeds or condemnation awards be made by the Association to any Owners if to do so would be in violation of the Indiana Not-For-Profit Corporation Act or if the same would constitute a distribution of earnings, profits or pecuniary gain to the members of the Association; in any such event, any such insurance proceeds or condemnation awards shall be retained by the Association for use in the payment of Common Expenses.

Section 4. Insurance by Owners. Each Owner shall have the right to purchase such additional insurance at his own expense as he may deem necessary.

Section 5. Condemnation Awards. All proceeds payable as a result of condemnation shall be paid to the Association who shall act as trustee and hold such proceeds for the benefit of the individual Owners.

Section 6. Restoration of Common Area. In the event of damage to or destruction of any of the Common Area due to fire or any other casualty or disaster, the Association shall promptly cause the same to be repaired and reconstructed. The proceeds of insurance carried by the Association, of any, shall be applied to the cost of such repair and reconstruction.

In the event the insurance proceeds, if any, received by the Association as a result of any such fire or any other casualty or disaster are not adequate to cover the cost of repair and reconstruction of the Common Area, or in the event there are no insurance proceeds, the cost for restoring the damage and repairing and reconstructing the Common Area so damaged or destroyed (or the costs thereof in excess of insurance proceeds received, if any) shall be assessed by the Association against all of the Owners in the same manner as is used for Regular Assessments. Any such amounts assessed against the Owners shall be assessed as part of the Common Expenses and shall constitute a lien from the time of assessment as provided herein.

For purposes of this Article, repair, reconstruction and restoration shall mean construction or rebuilding the Common Area to as near as possible the same condition as they existed immediately prior to the damage or destruction and with the same type of architecture.

ARTICLE IX

GENERAL PROVISIONS

Section 1. Acceptance and Ratification. All present and future Owners, Mortgagees, tenants and occupants of the Lots shall be subject to and shall comply with the provisions of this Declaration, the Articles of Incorporation, and the Bylaws incorporated herein by reference, and the rules and regulations as adopted by the Board of Directors as each may be amended from time to time. The acceptance of a deed of conveyance or the act of occupancy of any Lot shall constitute an agreement that the provisions of this Declaration, the Articles of Incorporation, the Bylaws, and rules and regulations, as each may be amended or supplemented from time to time, are accepted and ratified by such Owner, tenant or occupant, and all such provisions shall be covenants running with the land and shall be binding on any person having at any time any interest or estate in a Lot or the Real Estate as though such provisions were recited and stipulated at length in each and every deed, conveyance, mortgage or lease thereof. All persons, corporations, partnerships, trusts, associations, or other legal entities who may occupy, use, enjoy or control a Lot or Lots or any part of the Real Estate in any manner shall be subject to the Declaration, the Articles of Incorporation, the Bylaws, and the rules and regulations applicable thereto as each may be amended or supplemented from time to time.

Section 2. Negligence. Each Owner shall be liable for the expense of any maintenance, repair or replacement rendered necessary by his negligence or by that of any member of his family or his or their guests, employees, agents or lessees to the extent that such expense is not covered by the proceeds of insurance carried by the Association. An Owner shall pay the amount of any increase in insurance premiums occasioned by his use, misuse, occupancy or abandonment of his Lot or its appurtenances or of the Common Area.

Section 3. Costs and Attorneys' Fees. In any proceeding arising because of failure of an Owner to make any payments required or to comply with any provision of this Declaration, the Articles of Incorporation, the Bylaws, or the rules and regulations adopted pursuant thereto as each may be amended from



CHICAGO TITLE

time to time, the Association shall be entitled to recover its reasonable attorneys' fees incurred in connection with such default or failure.

Section 4. Waiver. No Owner may exempt himself from liability for his contribution toward the Common Expenses by waiver of the use or enjoyment of any of the Common Area or by abandonment of his Lot.

Section 5. Severability Clause. The invalidity of any covenant, restriction, condition, limitation or other provision of this Declaration, the Articles or the Bylaws, shall not impair or affect in any manner the validity, enforceability or effect of the rest of this Declaration, the Articles, or the Bylaws, and each shall be enforced to the greatest extent permitted by law.

Section 6. Pronouns. Any references to the masculine, feminine or neuter gender herein shall, unless the context clearly requires to the contrary, be deemed to refer to and include all genders. And the singular shall include and refer to the plural and vice versa as appropriate.

Section 7. Interpretation. The captions and titles of the various articles, sections or subsections of this Declaration are inserted herein for ease and convenience of reference only and shall not be used as an aid in interpreting or construing this Declaration or any provision hereof.

Section 8. Enforcement. The Association, any Owner, and the City of West Lafayette shall have the right to enforce, by any proceeding at law or in equity, all restrictions, conditions, covenants, reservations, liens and charges now or hereafter imposed by the provisions of this Declaration. The enforcing party shall be entitled to recovery of its costs and expenses of enforcement, including attorneys' fees, in any such enforcement action, provided that the Association or other enforcing party prevails in such action. Failure to enforce any covenant or restriction herein contained shall in no event be deemed a waiver of the right to do so thereafter.

Section 9. Effect of First Amended Declaration. This First Amended Declaration of Covenants, Conditions and Restrictions for Blackbird Farms Planned Development replaces, supercedes and renders null and void the Declaration of Covenants, Conditions and Restrictions for Blackbird Farms Planned Development heretofore executed by Declarant and recorded with the Tippecanoe County Recorder on February 2, 1990 as document number 90-01518.

IN WITNESS WHEREOF, the undersigned, being the Declarant herein, has caused this First Amended Declaration of Covenants, Conditions and Restrictions for Blackbird Farms Planned Development to be executed by Joseph A. Bonner, its President this 31st day of July, 1992.

LAFAYETTE BANK & TRUST COMPANY
By: Joseph A. Bonner
Joseph A. Bonner, President

ATTEST:
James C. Hilligoss
James C. Hilligoss
Vice President and
Assistant Secretary

STATE OF INDIANA)
COUNTY OF TIPPECANOE) SS:

Before me, the undersigned Notary Public, personally appeared Lafayette Bank & Trust Company, by Joseph A. Bonner, its President, and James C. Hilligoss, its Vice President and Assistant Secretary, who for and on behalf of said corporation acknowledged the execution of the foregoing instrument and swore to the truth of the statements made therein.

Witness my hand and Notarial Seal this 31st day of July, 1992.

Melinda C. Broadlove
Melinda C. Broadlove
Notary Public

My Commission Expires: 12-8-93
County of Residence: Tippecanoe

This instrument prepared by:
STUART & BRANIGIN
By: Erik D. Spykman

1609z

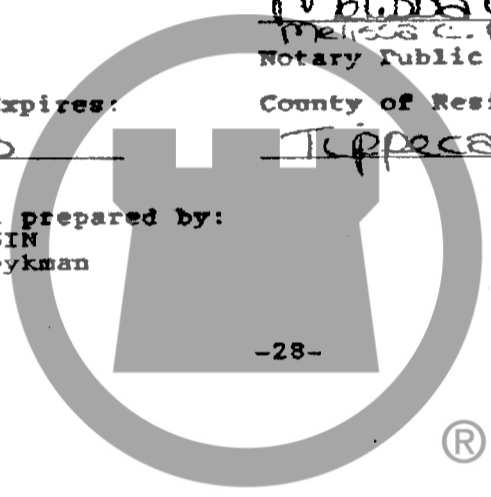

CHICAGO TITLE

EXHIBIT A
Legal Description of Real Estate

The North half of the Northwest Quarter of Section thirteen (13), Township Twenty-three (23) North, Range five (5) West, containing Eighty (80) acres, more or less.

Also, Lot 2 in Simmons Subdivision as recorded in Plat Book 14, Page 47, Slide A-53 in the Office of the Recorder, Tippecanoe County, Indiana, containing 0.92 acres, more or less.

DULY ENTERED FOR TAXATION
SUBJECT TO FINAL ACCEPTANCE
FOR TRANSFER.

Paul J. Michael
AUDITOR OF TIPPECANOE CO.
7-31-92 TN



CHICAGO TITLE

DULY ENTERED FOR TAXATION
SUBJECT TO FINAL ACCEPTANCE
FOR TRANSFER.

Betty L. Michael
AUDITOR OF TIPPECANOE CO.
4.28.94 TN

SECOND AMENDED DECLARATION
OF COVENANTS, CONDITIONS AND RESTRICTIONS
FOR BLACKBIRD FARMS PLANNED DEVELOPMENT

THIS SECOND AMENDED DECLARATION, made on the date hereinafter set forth by Lafayette Bank & Trust Company, an Indiana corporation, hereinafter referred to as "Declarant",

WITNESSETH:

WHEREAS, Declarant, as the owner of certain real estate in Wabash Township, Tippecanoe County, Indiana, which is more particularly described in the attached Exhibit A, which is incorporated herein by reference (the "Real Estate") executed a certain Declaration of Covenants, Conditions and Restrictions for Blackbird Farms Planned Development, and recorded said Declaration with the Tippecanoe County Recorder on February 2, 1990 as document number 90-01518;

WHEREAS, Declarant executed a certain First Amended Declaration of Covenants, Conditions and Restrictions for Blackbird Farms Planned Development, and recorded said Declaration with the Tippecanoe County Recorder on July 31, 1992 as document number 92-16830;

WHEREAS, Declarant now wishes to amend said Declaration in certain additional particulars and to restate all covenants, conditions and restrictions for Blackbird Farms Planned Development in this Second Amended Declaration of Covenants, Conditions and Restrictions for Blackbird Farms Planned Development (hereinafter referred to as "Declaration"),

NOW, THEREFORE, Declarant hereby declares that the Real Estate described above shall be held, sold and conveyed subject to the following easements, restrictions, covenants and conditions, which are for the purpose of protecting the value and desirability of, and which shall run with, the Real Estate and be binding on all parties having any right, title or interest in the Real Estate or any part thereof, their heirs, successors and assigns, and shall inure to the benefit of each Owner thereof.

ARTICLE I
DEFINITIONS

As used in this Declaration, the following terms shall have the following meanings, unless the context requires otherwise:

Section 1. "Articles" or "Articles of Incorporation" means the Articles of Incorporation of the Association, as amended from time to time. The Articles of Incorporation are incorporated herein by reference.

CHICAGO TITLE

Section 2. "Apartment Lot" means any one of Lots 189-191 within the Real Estate.

Section 3. "Association" means Blackbird Farms Homeowners Association, Inc., an Indiana not-for-profit corporation, its successors and assigns.

Section 4. "Blackbird Pond" means that body of water located in the Common Area, which is designed to handle the surface water drainage requirements of the Real Estate and is not to be construed to assure that water will be in the pond at all times or that any particular level of water will be contained therein.

Section 5. "Board of Directors" means the Board of Directors of the Association.

Section 6. "Bylaws" means the Bylaws of the Association, as amended from time to time.

Section 7. "Common Area" means all of the area designated as Common Area and Limited Common Area on the recorded Final Detailed Plans of Blackbird Farms Planned Development, including:

Common Areas A, B, C, D, E, F, G, H, I, J, K, L, M, N, and O in Blackbird Farms Planned Development, Phase One as recorded in Plat Cabinet AA-117 & 118 in the Tippecanoe County Recorder's Office and Platted in a part of the Northwest Quarter of Section 13, Township 23 North, Range 5 West, City of West Lafayette, Wabash Township, Tippecanoe County, Indiana;

AND

Lot 192 and Common Areas P, R, S, T, U, and V in Blackbird Farms Planned Development, Phase Two, Section One, and Replat of Lot 192 in Phase Three as recorded in Plat Cabinet AA-129 in the Tippecanoe County Recorder's Office and Platted in a part of the Northwest Quarter of Section 13, Township 23 North, Range 5 West, City of West Lafayette, Wabash Township, Tippecanoe County, Indiana

and all other Common Area Lots shown on the Plans (as hereinafter defined), including but not limited to Blackbird Pond and embankment areas of Blackbird Pond, all landscaped areas, driveways, sidewalks, parking areas and recreational areas, if any, but excluding all Lots (except Lot 192) and dedicated streets. The Common Area shall be conveyed to the Association not later than December 31, 1998, and (except with respect to the Limited Common Area, use of which is limited as provided elsewhere herein) is to be held for the common use and enjoyment of the Owners subject to the provisions hereof. ®

Section 8. "Common Expense" means expenses for administration of the Association and expenses for the upkeep, maintenance, repair and replacement of the Common Area and all other sums lawfully assessed against the Members of the Association, provided, however, that no expenditure for improvements to the Common Area in addition to the improvements shown on the Plans shall be deemed to be a Common Expense.

Section 9. "Declarant" means either Lafayette Bank & Trust Company or G&L Development Co., Inc.

Section 10. "Dwelling Unit" means one of the living units located upon a Lot.

Section 11. "Homestead Lot" means any of the following Lots within the Real Estate:

- a. If the Plans are not amended to reduce Lot density North of Kestral from 52 Lots to 35 Lots, "Homestead Lot" means Lots 1-81.
- b. If the Plans are amended to reduce Lot density North of Kestral from 52 Lots to 35 Lots, "Homestead Lot" means Lots 1-81 and Lots 136-170.

Section 12. "Limited Common Area" means the driveway areas abutting certain Lots, which are designated as Limited Common Area on the Plans and which will not be dedicated to the City of West Lafayette. The Limited Common Area may be used only for driveway purposes and only by the Owners of the Lots abutting such Limited Common Area, and the families, guests, lessees and invitees of such Owners.

Section 13. "Lot" means any plot of ground designated as such upon the recorded Final Plans of Blackbird Farms Planned Development or any part thereof and upon which any Dwelling Unit is constructed, is to be constructed or has existed. The term Lot shall be deemed to include the Dwelling Unit, if any, located thereon.

Section 14. "Member" means a member of the Association.

Section 15. "Mortgagee" means the holder of a first mortgage lien upon a Lot.

Section 16. "Owner" means a person, firm, corporation, partnership, association, trust or other legal entity, or any combination thereof, who owns fee simple title to a Lot.

®

Section 17. "Plans" means the recorded Final Detailed Plans of Blackbird Farms Planned Development, as amended from time to time.

Section 18. "Real Estate" means that certain real estate described in the attached Exhibit A.

Section 19. "Single-Family Lot" means any Homestead Lot or any Village Lot.

Section 20. "Village Lot" means any of the following Lots within the Real Estate:

- a. If the Plans are not amended to reduce Lot density North of Kestral from 52 Lots to 35 Lots, "Village Lot" means Lots 82-188.
- b. If the Plans are amended to reduce Lot density North of Kestral from 52 Lots to 35 Lots, "Village Lot" means Lots 82-135.

ARTICLE II

PROPERTY RIGHTS

Section 1. General Description of Property Rights. Every Owner of a Lot within the Real Estate will obtain fee simple ownership of said Lot and of the improvements constructed thereon. The Association will perform certain regular maintenance tasks on the Common Area within the Real Estate, as described herein. Every Owner will be required to perform all other repairs, replacements and maintenance on that Owner's Lot and upon any Dwelling Unit located thereon.

Section 2. Ownership of Common Area. The Common Area shall be conveyed to the Association not later than December 31, 1998, and shall be held for the use and enjoyment of the Owners, all of which shall have the right and easement of enjoyment and in to the Common Area (except the Limited Common Area, use of which is limited as provided elsewhere herein), which right shall pass with title to every Lot, subject to the provisions of this Declaration, including but not limited to the following:

- (a) The right of the Association, upon approval by vote of 75% of the Class A Members, to dedicate or transfer all or any part of the Common Area to any public agency, authority or utility for such Common Area purposes and upon such conditions as may be acceptable to the Association, provided that any such dedication or transfer shall be subject to acceptance thereof by the public agency.

®

CHICAGO TITLE

(b) The right of the Association or its Board of Directors to adopt such rules and regulations regarding use of the Common Area and recreational facilities, if any, by the Members.

(c) The right of the Association, in accordance with the Articles of Incorporation and Bylaws, to borrow after the Applicable Date for purposes of repairs, maintenance and replacement of improvements upon the Common Area. However, (a) until the Applicable Date the Association may not enter into any contract with a term exceeding one year; (b) all contracts to which the Association is a party shall be terminable on the Applicable Date; and (c) the Association may not borrow for any purpose before the Applicable Date without approval by 75% of the Class A Members.

Section 3. Delegation of Use. Any Owner may delegate, in accordance with the Bylaws, his right of enjoyment to the Common Area and facilities to the members of his family, his tenants or contract purchasers who reside on any Lot.

Section 4. Certain Encroachments and Easements. If by reason of inexactness of construction, settling after construction or for any other reason, any Common Area or improvement upon any Common Area encroaches upon any other Lot, an easement shall be deemed to exist and run to the Association for the maintenance, use and enjoyment of such Common Area. Further, if for said reasons any Dwelling Unit located upon a Village Lot encroaches upon the adjoining Lot by not more than one (1) foot, an easement shall be deemed to exist from the Owner of the Lot upon which said Dwelling Unit encroaches to the Owner of the encroaching Dwelling Unit. Each Owner of a Village Lot shall have an easement over and across any adjoining Lot for purposes of construction, maintenance and repair of such Owner's Dwelling Unit, provided that the Owner engaging in such construction, maintenance or repair shall upon conclusion of such work restore the adjoining Lot to its condition prior to commencement thereof. Each Owner shall have an easement in common with each other Owner to use all pipes, wires, ducts, cables, conduits, utility lines and other common facilities, if any, located in the Common Area and serving such Owner's Dwelling Unit. Notwithstanding the foregoing, no utility shall place any improvements or utility structures in any location upon the Real Estate which would interfere with any other improvement shown on the Plans.

Section 5. Easement for Utilities and Public Vehicles. All police, fire and other emergency vehicles, utility vehicles, trash and garbage collection vehicles, post-office vehicles and privately owned delivery vehicles shall have the right to enter upon the Common Area in the Real Estate in the performance of their duties. Notwithstanding the foregoing, garbage trucks,

street cleaning and snow removal equipment of the City of West Lafayette will provide service only upon the dedicated streets in the Real Estate and will not enter any of the Common Area driveways. All water, sewer, gas, electric, telephone and cable television utilities are to be underground. Street lighting is to be provided as shown on the Plans. An easement is also granted to all utilities and their agents for ingress, egress, installation, replacement, repair and maintenance of such utilities, including but not limited to water, sewer, gas, telephone and electricity on the Real Estate; provided, however, nothing herein shall permit the installation of sewers, electric lines, water lines or other utilities except as initially designed and approved by Declarant on the Plans or as thereafter may be approved by the Board of Directors. By virtue of this easement all of the foregoing utility companies are expressly permitted to erect and maintain the necessary equipment on the Real Estate and to affix and maintain electrical and telephone wires, circuits and conduits on and under the roofs and exterior walls of Dwelling Units. If any utility furnishing service requests a specific easement by a separate recordable document, the Board of Directors shall have the right to grant such easement upon the Real Estate without violating the terms hereof, provided that no such easement shall conflict with the Plans. The easements granted herein shall in no way affect any other recorded easement with respect to the Real Estate.

An easement is also granted to the Association, its officers, agents and employees and to any management company selected by the Association to enter upon or cross over any Lot or the Common Area to perform its duties.

ARTICLE III

ASSOCIATION MEMBERSHIP AND VOTING RIGHTS

Section 1. Membership. Every Owner of a Single-Family Lot shall be a Member of the Association. Membership shall be appurtenant to each Single-Family Lot and may not be separated from ownership of any such Single-Family Lot. The Owner(s) of the Apartment Lots shall not be Members of the Association and shall not be subject to the governance of the Association, nor shall the Apartment Lots have any obligation to pay Regular Assessments, Special Assessments or any other assessments, charges or payments of any kind to the Association, except payments relating to Blackbird Pond described in Article X hereof.

Section 2. Classes of Membership. The Association shall have two classes of membership:

Class A: Class A Members shall be all Owners of Single-Family Lots except the Declarant. Ownership of one Single-

CHICAGO TITLE

Family Lot shall be the sole qualification for Class A membership.

Class B: Class B Members shall be Declarant. Class B membership shall apply to any Single-Family Lot owned by Declarant. Class B membership shall cease and be converted to Class A membership upon the first to occur of the following dates (hereinafter referred to as the "Applicable Date"):

(a) the date when the written resignation of the Class B Member(s) as such is delivered to the registered agent of the Association; or

(b) the date when the total votes outstanding in Class A membership equal or exceed the total votes outstanding in Class B membership; or

(c) August 9, 1999.

The Class B membership of Declarant with respect to any individual Lot shall cease and be converted to Class A membership upon conveyance of that Lot by Declarant to any person or entity. The Class A membership of an Owner shall terminate when such person ceases to be the Owner of such Lot, and shall be transferred to the new Owner of such Lot.

Section 3. Voting Rights of Classes.

Class A: Class A Members shall be entitled to cast one vote for each Single-Family Lot owned by such Members on all matters submitted to a vote of the Members.

Class B: Class B Members shall be entitled to cast three votes for each Single-Family Lot owned by such Members on all matters submitted to a vote of the Members.

When more than one person is an Owner of a Lot, all such persons shall be Members in the applicable Class, but (except as provided above with respect to Class B members) their total vote shall not exceed one per Lot owned, and such vote shall be cast as one unit in such manner as the majority of the Owners of such Lot may agree. In the event such Owners fail to reach agreement, they shall not be entitled to vote and shall be considered as abstaining. In the event some of such Owners do not attend the meeting, in person or by proxy, those Owners who are in attendance, in person or by proxy, for purposes of determining the manner in which their vote shall be cast, shall be considered as the sole Owner of the Lot.

®

The Board of Directors may suspend the voting rights of a Member during any period in which such Member shall be in default in payment of any assessment levied by the Association.

Section 4. Functions. The Association has been formed for the purposes of providing for the maintenance, repair, upkeep, replacement, administration, operation and ownership of the Common Area, the enforcement of the covenants contained herein, the payment of taxes assessed against the Common Area, the payment of charges for utility service to the Common Area (including electricity for street lighting), and any other necessary expenses and costs in connection with the Common Area, except as otherwise limited hereby, and the performance of such other functions as may be designated to it to be performed under this Declaration.

Section 5. Board of Directors. The powers, limitations on powers, compensation, duties, qualifications, terms of office, method of election, method of removal and other provisions concerning the Board of Directors are as set forth in the Articles of Incorporation and the Bylaws. The Board of Directors shall be elected annually by the Members of the Association, in accordance with the procedures set forth in the Bylaws.

ARTICLE IV

COVENANT FOR MAINTENANCE ASSESSMENTS

Section 1. Purpose of Assessments. Maintenance, repairs, replacements and upkeep of the Common Area shall be provided by the Association as part of its duties and the cost thereof shall constitute part of the Common Expense. The Association's agreed portion of Blackbird Pond maintenance costs pursuant to Article X hereof also shall constitute part of the Common Expense. Each Owner shall be responsible for maintaining and keeping such Owner's Lot and all improvements thereon in a good, clean and sanitary condition at such Owner's expense.

Notwithstanding any obligation or duty of the Association to repair or maintain the Common Area, if due to the willful, intentional or negligent acts or omissions of an Owner or of a member of such Owner's family or a guest, tenant, invitee or other occupant or visitor of such Owner, damage shall be caused to the Common Area, or if maintenance, repairs or replacements shall be required thereby which would otherwise be a Common Expense, then such Owner shall pay for such damage and such maintenance, repairs and replacements as may be determined by the Association unless such loss is covered by an insurance policy owned by the Association. If not paid by such Owner upon demand by the Association, the cost of repairing such damage shall be added to and become part of the assessment to which such Owner's Lot is subject.

®

CHICAGO TITLE

If any Owner shall fail to maintain and keep such Owner's Lot or any part thereof in a good, clean and sanitary condition, exclusive of maintenance of the Dwelling Unit, the Association may perform any work necessary to do so and charge the Owner of such Lot for such cost, which cost shall be added to and become a part of the assessment to which such Owner's Lot is subject.

The assessments levied by the Association shall be used exclusively to promote the recreation, health, safety and welfare of the residents in the Real Estate and for the costs and expenses incident to operation of the Association, including without limitation snow removal for the Common Area, repair and replacement of improvements on the Common Area, and payment of other Common Expenses as defined in the Bylaws.

No expenditure for improvements to the Common Area in addition to the improvements shown on the Plans shall be deemed to be a Common Expense, and no assessment (other than a Special Assessment as hereinafter defined) shall be used to pay any expenditures for such additional improvements.

Notwithstanding any other provisions of this Declaration, the Articles of Incorporation or the Bylaws, the Owner(s) of the Apartment Lots shall not be Members of the Association and shall not be subject to the governance of the Association, nor shall the Apartment Lots have any obligation to pay Regular Assessments, Special Assessments or any other assessments, charges or payments of any kind to the Association.

Section 2. Annual Accounting. Annually, after the close of each fiscal year of the Association and prior to the date of the annual meeting of the Association next following the end of such fiscal year, the Board of Directors shall cause to be prepared and furnished to each Owner a financial statement prepared by a certified public accountant or firm of certified public accountants then servicing the Association, which statement shall show all receipts and expenses received, incurred and paid by the Association during the preceding fiscal year.

Section 3. Proposed Annual Budget. Annually, before the date of the annual meeting of the Association, the Board of Directors shall cause to be prepared a proposed annual budget for the next fiscal year estimating the total amount of the Common Expenses for the next fiscal year and shall furnish a copy of such proposed budget to each Owner at or prior to the time the notice of such annual meeting is mailed or delivered to such Owners. The annual budget shall be submitted to the Owners at the annual meeting of the Association for adoption, and, if so adopted, shall be the basis for the Regular Assessments (as hereinafter defined) for the next fiscal year. At the annual meeting of the Owners, the budget may be approved in a whole or in part or may be amended

in whole or in part by a majority vote of the Owners; provided, however, that in no event shall the annual meeting of the Owners be adjourned until an annual budget is approved and adopted at such meeting, either the proposed annual budget or the proposed annual budget as amended. The annual budget, the Regular Assessments and all sums assessed by the Association shall be established by using generally accepted accounting principles applied on a consistent basis.

The annual budget may include the establishment and maintenance of a replacement reserve fund for replacement and repair of the Common Area, which replacement reserve fund (if established) shall be used for those purposes and not for usual and ordinary repair expenses. Such replacement reserve fund for replacement and repair of the Common Area shall be maintained by the Association in a separate interest bearing account or accounts with one or more banks or savings and loan associations authorized to conduct business in Tippecanoe County, Indiana selected from time to time by the Board of Directors.

The failure or delay of the Board of Directors to prepare a proposed annual budget and to furnish a copy thereof to the Owners shall not constitute a waiver or release in any manner of the obligations of the Owners to pay the Common Expenses as herein provided, whenever determined. Whenever, whether before or after the annual meeting of the Association, there is no annual budget approved by the Owners as herein provided for such current fiscal year, the Owners shall continue to pay Regular Assessments based upon the last approved budget or, at the option of the Board of Directors, based upon one hundred and ten percent (110%) of such last approved budget, as a temporary budget.

Section 4. Regular Assessments After the Applicable Date. The annual budget as adopted by the Owners shall, based on the estimated cash requirement for the Common Expenses in the fiscal year as set forth in said budget, contain a proposed assessment against each Single-Family Lot. The total amount of the annual budget shall be divided equally among the Single-Family Lots. Immediately following the adoption of the annual budget, each Owner of a Single-Family Lot shall be given written notice of such assessment against his respective Single-Family Lot (herein called the "Regular Assessment"). In the event the Regular Assessment for a particular fiscal year is initially based upon a temporary budget, such Regular Assessment shall be revised, within fifteen (15) days following adoption of the final annual budget by the Owners, to reflect the assessment against each Single-Family Lot based upon such annual budget as finally adopted by the Owners. The aggregate amount of the Regular Assessments shall be equal to the total amount of expenses provided and included in the final annual budget, including any reserve funds as hereinabove provided. The Regular Assessment against each Single-Family Lot shall be paid in advance in one annual installment, payable in

advance on or before the first day of each fiscal year of the Association. Payment of the Regular Assessment shall be made to the Board of Directors or any Managing Agent, as directed by the Board of Directors. In the event the Regular Assessment for a particular fiscal year of the Association was initially based upon a temporary budget:

- (i) if the Regular Assessment based upon the final annual budget adopted by the Owners exceeds the amount of the Regular Assessment based upon the temporary budget, such excess shall be payable on or before the first day of the second month following the determination of the Regular Assessment based upon the annual budget finally adopted by the Owners, or
- (ii) if the Regular Assessment based upon the temporary budget exceeds the Regular Assessment based upon the final annual budget adopted by the Owners, such excess shall be refunded to the Owner on or before the first day of the second month following the determination of the Regular Assessment based upon the annual budget finally adopted by the Owners.

The Regular Assessment for the current fiscal year of the Association shall become a lien on each Single-Family Lot as of the first day of each fiscal year of the Association, even though the final determination of the amount of such Regular Assessment may not have been made by that date. The fact that an Owner has paid his Regular Assessment for the current fiscal year in whole or in part based upon a temporary budget and thereafter, before the annual budget and Regular Assessment are finally determined, approved and adjusted as herein provided, sells, conveys or transfers his Single-Family Lot or any interest therein, shall not relieve or release such Owner or his successor as Owner of such Single-Family Lot from payment of the Regular Assessment for such Single-Family Lot as finally determined, and such Owner and his successor as Owner of such Single-Family Lot shall be jointly and severally liable for the Regular Assessment as finally determined. Any statement of unpaid assessments furnished by the Association pursuant hereto prior to the final determination and adoption of the annual budget and Regular Assessment for the year in which such statement is made shall state that the matters set forth therein are subject to adjustment upon determination and adoption of the final budget and Regular Assessment for such year, and all parties to who any such statement may be delivered or who may rely thereon shall be bound by such final determinations. Regular Assessments shall be due and payable automatically on their respective due dates without any notice from the Board of Directors or the Association, and neither the Board of Directors nor the Association shall be responsible for providing any notice or statements to Owners for the same.

®

CHICAGO TITLE

Section 5. Special Assessments. From time to time Common Expenses of an unusual or extraordinary nature or not otherwise anticipated may arise. At such time and provided that any such assessment shall have the assent of sixty-seven percent (67%) of all Members who are voting in person or by proxy at a meeting duly called for this purpose, the Board of Directors shall have the full right, power and authority to make special assessments which, upon resolution of the Board of Directors, shall become a lien on each Single-Family Lot, divided among Single-Family Lots in the same manner as is set forth above with respect to Regular Assessments (hereinafter referred to as "Special Assessment"). Without limiting the generality of the foregoing provisions, Special Assessments may be made by the Board of Directors from time to time to pay for capital expenditures and to pay for the cost of any repair or reconstruction of damage caused by fire or other casualty or disaster to the extent insurance proceeds are insufficient therefor under the circumstances described in this Declaration. For purposes of this section, repair, reconstruction and restoration shall mean construction or rebuilding the Common Area to as near as possible the same condition as they existed immediately prior to the damage or destruction and with the same type of architecture. No Special Assessment will be made until after the first annual meeting of the Association after the Applicable Date without the prior approval of 75% of the Class A Members.

Section 6. Regular Assessments Prior to the Applicable Date. During the period that Dwelling Units are being constructed within the Real Estate, it is difficult to accurately allocate the Common Expenses to the individual Single-Family Lots. The purpose of this Section is to provide the method of the payment of the Common Expenses during the period prior to the Applicable Date to enable the Association to perform its duties and functions. Accordingly, and notwithstanding any other provision contained in the Declaration, the Articles or the Bylaws or otherwise, prior to the Applicable Date, the annual budget and all Regular Assessments and Special Assessments shall be established by the Board of Directors without any meeting or concurrence of the Owners; provided, however, the Regular Assessments shall be determined in accordance with the provisions contained in this Section.

The Association may enter into a management agreement with Declarant (or a corporation or other entity designated by Declarant) (hereinafter referred to as "Management Agent" or "Managing Agent") in accordance with the provisions of this Declaration. So long as such management agreement (or any similar agreement) remains in effect, the Common Expenses and Regular Assessments shall be paid by Owners to Management Agent. Declarant agrees that until the earlier of (1) the termination of said management agreement or (2) 1 year after the date of execution thereof, the Regular Assessment shall not exceed One Hundred Dollars (\$100) per year (the "Guaranteed Maximum Charge").

After this date (assuming that said management agreement or similar agreement is still in effect) and so long thereafter as said management agreement (or similar agreement) remains in effect and the Management Agent continues to perform such functions, Declarant guarantees that the Regular Assessment shall not exceed the amount of the Guaranteed Maximum Charge plus a maximum of a ten percent (10%) increase in the Guaranteed Maximum Charge for each year. Such adjustments to the Guaranteed Maximum Charge (up to a ten percent (10%) annual increase as determined by the Board of Directors) shall be made annually on January 1 of each year so long as said management agreement remains in effect and the Management Agent continues to perform such functions. Payment of such charge shall during such guaranteed period entirely defray the Owner's entire obligation for his share of Common Expenses and shall be the Owner's entire Regular Assessment. Declarant shall be responsible for any deficit during such guarantee period; provided, however, that this guarantee is not intended to include, and does not include, major physical alterations or other capital expenditures not ordinarily anticipated in normal maintenance operations. Such expenditures, if any, must be covered through Special Assessments.

Notwithstanding any provision herein to the contrary, the Guaranteed Maximum Charge shall remain at One Hundred Dollars (\$100) per year through December 31, 1995.

That portion of the Regular Assessment collected by Declarant prior to the Applicable Date applicable to any replacement reserve created shall be held by the initial Board of Directors and shall not be expended until after the first meeting of Members after the Applicable Date. Any such replacement reserve collected by Declarant prior to the Applicable Date shall be retained by the Association at the Applicable Date.

Payment of Regular Assessments prior to the Applicable Date with respect to each Lot not owned by Declarant shall commence on the date of conveyance by Declarant to such new Owner. The first payment shall be payable on the date of conveyance, with the amount thereof prorated to said date of conveyance. Thereafter, payment of the Regular Assessment shall be paid the first day of each fiscal year during the period prior to the Applicable Date.

Each Owner hereby authorizes the Association and the Board of Directors and its officers to enter into the management agreement described in this Declaration and to adhere to and abide by the same. Any management agreement with Declarant or its designee shall terminate on the Applicable Date and shall not provide for payment of any management fee to Declarant or its designee.

Section 7. Failure of Owner to Pay Assessments. No Owner may exempt himself from paying Regular Assessments and Special Assessments or from contributing toward the Common Expense or

toward any other expense lawfully agreed upon by waiver of the use or enjoyment of the Common Area or by abandonment of the Single-Family Lot belonging to him. Each Owner shall be personally liable for the payment of all Regular and Special Assessments. Where the Owner constitutes more than one person the liability of such persons shall be joint and several. If any Owner shall fail, refuse or neglect to make any payment of any Regular Assessment or Special Assessment when due, the lien for such assessment on the Owner's Single-Family Lot and Dwelling Unit may be filed and foreclosed by the Association as a mortgage on real property or as otherwise provided by law. Upon the failure of the Owner to make timely payments of any Regular Assessment or Special Assessment when due the Board of Directors may in its discretion accelerate the entire balance of unpaid assessments for the current fiscal year and the Owner and any occupant of the Single-Family Lot and Dwelling Unit shall be jointly and severally liable for the payment to the Association and the Board of Directors shall be entitled to the appointment of a receiver for the purpose of preserving the Single-Family Lot and Dwelling Unit and to collect the rentals and other profits therefrom for the benefit of the Association to be applied to the unpaid Regular Assessments or Special Assessments. The Board of Directors may at its option bring suit to recover a money judgment for any unpaid Regular Assessment or Special Assessment without foreclosing or waiving the lien securing the same. Any action to recover a Regular Assessment or Special Assessment whether by foreclosure or otherwise the Board of Directors for and on behalf of the Association shall be entitled to recover from the Owner of the respective Single-Family Lot and Dwelling Unit costs and expenses of such action incurred (including but not limited to reasonable attorneys fees) and interest from the date such assessments were due until paid at the rate equal to the prime interest rate then being charged by Lafayette Bank & Trust Company, Lafayette, Indiana its largest and best corporate customer (or if said bank is no longer in existence then such rate charged by another national bank in Tippecanoe County, Indiana selected by the Board of Directors).

Section 8. Subordination of Assessment Lien to Mortgage. Notwithstanding anything contained in this Declaration, the Articles or the Bylaws, any sale or transfer of a Single-Family Lot to a Mortgagee pursuant to a foreclosure on its mortgage or conveyance in lieu thereof, or a conveyance to any person at a public sale in a manner provided by law with respect to mortgage foreclosure shall extinguish the lien of any unpaid installment of any Regular Assessment or Special Assessment as to such installment which became due prior to such sale, transfer or conveyance; provided, however, that the extinguishment of such lien cannot relieve the prior Owner from personal liability therefor. No such sale, transfer or conveyance shall relieve the Single-Family Lot and Dwelling Unit or the purchaser at such foreclosure sale or grantee in the event of conveyance in lieu

thereof, from liability for any installments of Regular Assessments or Special Assessments thereafter becoming due or from the lien therefor. Such unpaid share of any Regular Assessments or Special Assessments, the lien for which has been divested as aforesaid shall be deemed to be a Common Expense collectible from all Owners (including the party acquiring the subject Single-Family Lot from which it arose).

ARTICLE V

COVENANTS AND RESTRICTIONS

The following covenants and restrictions on the use and enjoyment of the Lots, Dwelling Units and Common Area shall be in addition to any other covenants or restrictions contained herein and in the Plans, and all such covenants and restrictions are for the mutual benefit and protection of the present and future Owners and shall run with the land and inure to the benefit of and be enforceable by any Owner, or by the Association. Any conflict between this Declaration and the Plans shall be controlled by the Plans. Present or future Owners or the Association shall be entitled to injunctive relief against any violation or attempted violation of any such covenants and restrictions, and shall, in addition, be entitled to damages for any injuries or losses resulting from any violations thereof, but there shall be no right of reversion or forfeiture resulting from such violation. These covenants and restrictions are as follows:

Section 1. Subject to U.S. Postal Regulations, the Association reserves the right to approve the type of mailboxes installed on the Real Estate.

Section 2. All Lots and Dwelling Units shall be used exclusively for residential purposes and for occupancy by a single family, except the Lots 189-191, which shall be used for multi-family apartment buildings. Except as hereinafter provided, no structure shall be erected or placed on any Single-Family Lot other than one single-family dwelling and a private garage for two or three vehicles. The total living area of a one-story Dwelling Unit on a Homestead Lot shall be not less than 1400 square feet and the total living area of a two-story dwelling house on a Homestead Lot shall be not less than 1800 square feet. The total living area of a one-story Dwelling Unit on a Village Lot shall be not less than 1350 square feet and the total living area of a two-story dwelling house on a Village Lot shall be not less than 1500 square feet. The foregoing square footage minimums are exclusive, in all cases, of porches, decks, patios, garages and similar areas not regarded as living areas.

The total foundation area (including garage) of a Dwelling Unit on a Homestead Lot shall be not greater than thirty percent

(30%) of the total foundation area of the Lot upon which such Dwelling Unit is constructed. The total foundation area (including garage) of a Dwelling Unit on a Village Lot shall be not greater than forty percent (40%) of the total foundation area of the Lot upon which such Dwelling Unit is constructed.

Each Dwelling Unit on a Single-Family Lot shall have a garage capable of housing two or three automobiles. Other structures which are consistent with the high-quality residential character of the neighborhood may be erected or placed on Lots only with the express written approval of the Architectural Review Board as hereinafter described. No changes in the exterior dimensions of Dwelling Units located on Village Lots shall be made without approval of the Architectural Review Board.

On Village Lots, Dwelling Units may not be constructed nearer than twelve (12) feet from the Lot line opposite the Lot line used as a "zero lot line"

Section 3. Real estate taxes are to be separately assessed and taxed to each Lot. Any real estate taxes or other assessments which are chargeable against the Common Area shall be paid by the Association and treated as a Common Expense.

Section 4. Each Owner shall pay for his own utilities which are separately metered. Utilities which are not separately metered, if any, shall be treated as and paid as part of the Common Expense unless otherwise determined by the Association.

Section 5. All driveways shall be of concrete or blacktop construction and shall be built no later than thirty (30) days after a new Dwelling Unit is occupied, weather permitting.

Section 6. No permanent outside clothesline shall be erected, placed or allowed to remain on the Real Estate.

Section 7. No Owner shall permit anything to be done or kept in his Dwelling Unit or on his Lot or on any of the Common Area which will result in a cancellation of insurance or increase in insurance on any part of the Common Area, or which would be in violation of any law or ordinance or the reasonable requirements of any insurance underwriting or rating bureau.

Section 8. No nuisance shall be permitted and no waste shall be committed in any Dwelling Unit, the Common Area or on any Lot.

Section 9. No Owner shall cause or permit anything to be hung or displayed on the outside of the windows of his Dwelling Unit or placed on the outside walls of any building, and no sign, awning, canopy or radio or television antenna or other attachment or thing shall be affixed to or placed upon the exterior walls or

®

roofs or any other parts of any building without the prior written consent of the Architectural Review Board.

Section 10. No animals, livestock or poultry of any kind shall be raised, bred or kept in any Dwelling Unit or on any Lot or any of the Common Area, except that pet dogs, cats or customary household pets may be kept in a Dwelling Unit, provided that such pet is not kept, bred or maintained for any commercial purpose, and does not create a nuisance. Pets shall be taken outdoors only under leash or other restraint and while attended by its owner. Any pet which is causing or creating a nuisance or unreasonable disturbance or noise, shall be permanently removed from the Real Estate within ten (10) days after written notice from the Board of Directors to the respective Owner to do so.

Section 11. The common Area shall be kept free and clear of rubbish, debris and other unsightly materials.

Section 12. Except for management of the affairs of the Association, no industry, business, trade, occupation or profession of any kind shall be conducted, maintained or permitted on the Real Estate; provided, however, this restriction shall not be construed to prevent an Owner from (a) maintaining his professional library therein; (b) keeping his personal, business or professional records or accounts therein; or (c) handling his personal business or professional telephone calls or correspondence therein. Such uses are expressly declared customarily incident to the principal residential use and not in violation of any restrictions under this Section.

Section 13. "For sale," "for rent" or "for lease" signs may be displayed upon the Real Estate only for reasonable periods and only upon the Lot to which such sign relates. No other sign or other window or advertising display shall be maintained or permitted on any part of the Real Estate, any Lot or any dwelling Unit without the prior consent of the Board of Directors; provided, however, that the right is reserved by the Declarant and the Board of Directors to place or allow to be placed "for sale" of "for lease" and other signs on or about the Real Estate in connection with any unsold or unoccupied Lots and Dwelling Units.

Section 14. All Owners and members of their families, their guests, or invitees, and all occupants of any Dwelling Unit or other persons entitled to use the same and to use and enjoy the Common Area or any part thereof, shall observe and be governed by such rules and regulations as may from time to time be promulgated and issued by the Board of Directors governing the operation, use and enjoyment of the Common Area. Before the Applicable Date, all rules and regulations for the Common Area shall be subject to prior approval of 75% of the Class A Members.

®

Section 15. No repair work shall be done on the Real Estate on any vehicles, including passenger automobiles. No truck of any kind that requires a "truck license", no boat or trailer and no unlicensed vehicle shall be parked or permitted to remain on any Lot or any Common Area unless the same is enclosed by a garage and not exposed to view. Trucks making deliveries or present in connection with service, repair or construction within the Real Estate are excepted. Other vehicles of any kind except conventional passenger cars shall not be parked or permitted to remain on any Lot or any Common Area for a period in excess of forty-eight (48) hours unless enclosed by a garage and not exposed to view. The purpose of this restriction is to preserve the overall appearance and integrity of the neighborhood. The parking restrictions set forth herein may be altered, amended or supplemented by the Board of Directors, provided that all such alterations, amendments and supplements shall be designed to achieve the purposes set forth in the preceding sentence.

Section 16. No Owner shall be allowed to plant trees, landscape or do any gardening in any of the Common Area, except with express permission from the Board of Directors.

Section 17. The Common Area shall be used and enjoyed only for the purposes for which it is designed and intended, and shall be used subject to the rules and regulations from time to time adopted by the Board of Directors.

Section 18. No boats shall be permitted on Blackbird Pond.

Section 19. No swimming shall be permitted in Blackbird Pond.

Section 20. No Owner may rent or lease his Dwelling Unit for transient or hotel purposes.

Section 21. No noxious or offensive trade or activity shall be carried on upon any of the Real Estate, nor shall anything be done thereon which may be or become an annoyance or nuisance to the neighborhood. No property shall be used or maintained as a dumping ground for rubbish. Trash, garbage or other waste shall be kept in sanitary containers. All equipment for the storage or disposal of such material shall be kept in a clean and sanitary condition and out of view of other Lots and the street, except that garbage containers may be placed within view for the purpose of garbage pick-up.

Section 22. Any Owner who leases a Dwelling Unit shall lease the entire Dwelling Unit and shall have a written lease which shall provide that the lease is subject to the provisions of the Declaration and any failure of the lessee to comply with the terms of the Declaration, shall be a default under the lease. A copy of each such lease shall be provided to the Association.

Section 23. The Board of Directors from time to time may promulgate further rules and regulations concerning the use of Single-Family Lots and the Common Area. Copies of rules and regulations shall be furnished by the Board of Directors to the Owners prior to the time when they shall be effective. Before the Applicable Date, all rules and regulations for the Common Area shall be subject to prior approval of 75% of the Class A Members.

Section 24. No-access easements are hereby reserved as shown on the Plans. Along these lines, no vehicular access shall be permitted to or from the adjoining streets. This restriction may be enforced by the Tippecanoe County Area Plan Commission and shall be irrevocable except with the prior approval of the Tippecanoe County Area Planning Commission.

Section 25. Lots 25-28, 34-36 and 38-44 in the Real Estate are subject to a reservation of a forty (40) foot wide strip of land along the eastern boundary of said Lots as shown on the Plans, for street right-of-way purposes. No structures may be placed within the reserved area of said Lots. If within five (5) years after the date of recordation of the Plans said reserved area has neither been acquired by a public body or agency nor have condemnation proceedings been commenced against said reserved area, the reserved designation shall be deemed removed from said reserved area without further action by Declarant or any other party. Owners of the reserved area shall be responsible for maintenance thereof.

Section 26. No Dwelling Unit shall be located nearer to the Lot line of any Lot in the Real Estate than the building setback lines shown on the Plans, provided that the following additional restriction shall apply to Homestead Lots: any garage constructed upon any corner Lot and having a vehicular access door facing the side street shall be located no nearer than twenty (20) feet from the side Lot line.

Notwithstanding anything to the contrary contained herein or in the Articles or Bylaws, including, but not limited to, any covenants and restrictions set forth herein or otherwise, Declarant shall have the right to use and maintain any Lots and Dwelling Units owned by Declarant and other portions of the Real Estate (other than individual Dwelling Units and Lots owned by Persons other than Declarant), all of each number and size and at such locations as Declarant in its sole discretion may determine, as Declarant may deem advisable or necessary in its sole discretion to aid in the construction of Dwelling Units and the sale of Lots and Dwelling Units or for the conducting of any business or activity attendant thereto, including, but not limited to, model Dwelling Units, storage areas, construction yards, signs, construction offices, sales offices, management offices and business offices. Declarant shall have the right to relocate any or all of the same from time to time as it desires. At no time

shall any of such facilities so used or maintained by Declarant be or become part of the Common Area, unless so designated by Declarant, and Declarant shall have the right to remove the same from the Real Estate at any time. Notwithstanding the foregoing, Declarant's use of the Real Estate as provided above shall be limited to uses directly related to sale of Lots in the Real Estate, and development, construction and management of the Real Estate.

ARTICLE VI

AMENDMENT OF DECLARATION

Section 1. Generally. Except as otherwise provided in this Declaration, after the Applicable Date amendments to this Declaration shall be proposed and adopted in the following manner:

- (i) Notice. Notice of the subject matter of any proposed amendment shall be included in the notice of the meeting at which the proposed amendment is to be considered.
- (ii) Resolution. A resolution to adopt a proposed amendment may be proposed by the Board of Directors or by Owners having in the aggregate at least a majority of the votes of all Owners.
- (iii) Meeting. The resolution concerning a proposed amendment must be adopted by the designated vote at a meeting duly called and held in accordance with the provisions of the Bylaws.
- (iv) Adoption. Any proposed amendment to this Declaration must be approved by a vote of not less than seventy-five percent (75%) of the Class A Members.
- (v) Special Amendments. No amendment to this Declaration shall be adopted which changes (1) the applicable share of an Owner's liability for the Common Expenses, or the method of determining the same, or (2) the provision of this Declaration with respect to casualty insurance or fidelity bonds to be maintained by the Association, or (3) the provisions of this Declaration with respect to reconstruction or repair of the Common Area in the event of Fire or any other casualty or disaster, or (4) the provisions of this Declaration establishing the Architectural Review Board and providing for its functions, or (5) the provisions of this Declaration with respect to the commencement of

assessments on any Lot, without, in each and any of such circumstances, the unanimous approval of all Owners.

- (vi) Additional Special Amendments. No amendment to this Declaration shall be adopted which imposes a right to first refusal or similar restriction or which changes (1) the method of voting, or (2) reserves for and responsibility for maintenance, repair and replacement of the Common Area, or (3) annexation of property to the Real Estate, or (4) the leasing of Dwelling Units, or (5) termination of the applicability of this Declaration, without the consent of at least ninety percent (90%) of the votes of the Class A Members for the first twenty (20) years after recording of this Declaration and thereafter at least seventy-five percent (75%) of the votes of the Class A Members.
- (vii) Recording. Each amendment to the Declaration shall be executed by the President and Secretary of the Association and shall be recorded in the office of the Recorder of Tippecanoe County, Indiana, and such amendment shall not become effective until so recorded.

Section 2. Amendments by Declarant Only. Notwithstanding the foregoing or anything elsewhere contained herein or in any other documents, the Declarant shall have and hereby reserves the right and power acting alone and without the consent or approval of the Owners, the Association, the Board of Directors, any Mortgagee or any other person to amend or supplement this Declaration at any time and from time to time if such amendment or supplement is made (a) to comply with requirements of the Federal National Mortgage Association, the Government National Mortgage Association, the Federal Home Loan Mortgage Corporation, the Department of Housing and Urban Development, or any other governmental agency or any other public, quasi-public or private entity which performs (or may in the future perform) functions similar to those currently performed by such entities, (b) to induce any of such agencies or entities to make, purchase, sell, insure or guarantee first mortgages covering lots and Dwelling Units, (c) to bring this declaration into compliance with any requirements of applicable statutes, regulations or ordinances or (d) to correct clerical or typographical errors in this Declaration or Exhibit A hereto or any amendment to this Declaration. In furtherance of the foregoing, a power coupled with an interest is hereby reserved and granted to the Declarant to vote in favor of, make, or consent to any such amendments on behalf of each Owner as proxy or attorney-in-fact, as the case may be. Each deed, mortgage, trust deed, other evidence of obligation, or other instrument affecting a Lot or Dwelling Unit

and the acceptance thereof shall be deemed to be a grant and acknowledgment of, and a consent to the reservation of, the power to the Declarant to vote in favor of, make, execute and record any such amendments. The right of the Declarant to act pursuant to rights reserved or granted under this Section shall terminate on the earlier of the following dates: (a) the date when the Declarant no longer hold or controls title to any part or portion of the Real Estate; (b) the Applicable Date; or (c) December 31, 1998.

Section 3. Amendment Prior to the Applicable Date. Notwithstanding anything to the contrary contained herein, there shall be no amendment of the Declaration prior to the Applicable Date without the consent and approval of Declarant.

Section 4. Approval of Amendments. Notwithstanding anything to the contrary contained herein, there shall be no amendment of the Declaration without the prior approval of the Tippecanoe County Area Plan Commission and the West Lafayette City Council through the planned development rezoning process, which includes the possibility of consideration as a minor modification by the Administrative Officer of the City of West Lafayette.

ARTICLE VII

ARCHITECTURAL CONTROL

Section 1. Architectural Control.

(a) The Architectural Review Board. As a standing committee of the Association, there shall be, and hereby is, established an Architectural Review Board consisting of three (3) or more persons as may, from time to time, be provided in the Bylaws. Until the Applicable Date, the Architectural Review Board shall be the Initial Board of Directors. After the Applicable Date, the Architectural Review Board shall be appointed by the Board of Directors.

(b) Purposes. The Architectural Review Board shall regulate the external design, appearance, use and location of improvements on the Real Estate in such manner as to preserve and enhance values and to maintain a harmonious relationship among structures, improvements and the natural vegetation and topography.

(c) Conditions. No improvements, alterations, repairs, excavation, changes in grade or other work which in any way alters the exterior of any Lot or the improvements located thereon from its natural or improved state existing on the date such Lot was first conveyed in fee by the Declarant to an Owner shall be made or done without the prior approval of the Architectural Review Board, except as otherwise expressly provided in this Declaration.

No building, fence, wall, Dwelling Unit, or other structure shall be commenced, erected, maintained, improved, altered, made or done on any Lot without the prior written approval of the Architectural Review Board.

(d) Procedures. In the event the Architectural Review Board fails to approve, modify or disapprove in writing an application within thirty (30) days after such application (and all plans, drawings, specifications and other items required to be submitted to it in accordance with such rules as it may adopt) have been given to it, approval will be deemed granted by the Architectural Review Board. A decision of the Architectural Review Board may be appealed to the Board of Directors which may reverse or modify such decision by a two-thirds (2/3) vote of the Directors then serving. The Architectural Review Board may establish committees consisting of two (2) or more of its members, which committees shall exercise such powers of the Board of Directors as may be delegated to them.

(e) Maintenance of Architectural Control. The Association may not waive or abandon the procedure for regulating and enforcing the architectural design of the Dwelling Units nor for maintaining the Common Area (including the upkeep of common fences, driveways, lawns and plantings) without the prior written approval of all Owners.

ARTICLE VIII

INSURANCE

Section 1. Public Liability Insurance. The Association shall also purchase a master comprehensive public liability insurance policy in such amount or amounts as the Board of Directors shall deem appropriate from time to time but not less than \$1,000,000 for bodily injury, including deaths of persons and property damage arising out of a single occurrence. Such comprehensive public liability insurance policy shall cover the Association, the Board of Directors, any committee or organ of the Association or Board of Directors, any Member, any Managing Agent appointed or employed by the Association and all persons acting or who may come to act as agents or employees of any of the foregoing with respect to the Real Estate. Such public liability insurance policy shall contain a provision that such policy shall not be cancelled or substantially modified without at least ten (10) days written notice to the Association.

Section 2. Other Insurance. The Association shall also obtain any other insurance required by law to be maintained, including but not limited to workmen's compensation, and such other insurance as the Board of Directors shall from time to time deem necessary, advisable or appropriate, including, but not

limited to, liability insurance on vehicles owned or leased by the Association and officers' and directors' liability policies. Such insurance shall inure to the benefit of each Member, the Association, the Board of Directors and any Managing Agent acting on behalf of the Association. Each Member shall be deemed to have delegated to the Board of Directors his right to adjust with the insurance companies all losses under the policies purchased by the Board of Directors policies purchased by the Board of Directors the proceeds of which are payable to the Board of Directors or the Association.

Section 3. General Provisions. The premiums for all insurance hereinabove described shall be paid by the Association as part of the Common Expenses. When any such policy of insurance hereinabove described has been obtained by or on behalf of the Association, written notice of the obtainment thereof and of any subsequent changes therein or termination thereof shall be promptly furnished to each Owner, which notice shall be furnished by the officer of the Association who is required to send notices of meetings of the Association. Under no circumstances shall any distribution of insurance proceeds or condemnation awards be made by the Association to any Owners if to do so would be in violation of the Indiana Not-For-Profit Corporation Act or if the same would constitute a distribution of earnings, profits or pecuniary gain to the members of the Association; in any such event, any such insurance proceeds or condemnation awards shall be retained by the Association for use in the payment of Common Expenses.

Section 4. Insurance by Owners. Each Owner shall have the right to purchase such additional insurance at his own expense as he may deem necessary.

Section 5. Condemnation Awards. All proceeds payable as a result of condemnation of Common Areas shall be paid to the Association who shall act as trustee and hold such proceeds for the benefit of the individual Owners.

ARTICLE IX

ACCESS TO RECREATIONAL FACILITIES

Section 1. Access to Facilities. Subject to the terms and conditions of this Article IX, the Owner of the Apartment Lots (the "Apartment Owner") agrees to extend to Members of Association in good standing the right to use the Apartment Owner's clubhouse, swimming pool and tennis court facilities (the "Facilities") located on the real estate described below, subject to payment of an annual fee as described in this Article by each Member of Association who wishes to use the Facilities during any calendar year:

®

CHICAGO TITLE

Legal Description of the Facilities

A part of Lot 189 in Blackbird Farms, Phase Three, Planned Development, as platted in a part of the North Half of Section 13, Township 23 North, Range 5 West, City of West Lafayette, Wabash Township, Tippecanoe County, Indiana, that part of Lot 189 being more completely described as follows:

Commencing at the northeastern corner of said Lot 189, said point being on the southern right-of-way line of Kestral Boulevard; thence Northwesterly along the southern right-of-way line of Kestral Boulevard on a curve to the left, having a radius point bearing South $61^{\circ} 18' 00''$ West, 250.00 feet, a central angle of $50^{\circ} 16' 33''$, a radius of 250.00 feet, an arc distance of 219.37 feet to the point of beginning of this description; thence South $00^{\circ} 00' 00''$ West, 248.76 feet; thence North $90^{\circ} 00' 00''$ West, 115.00 feet; thence North $00^{\circ} 00' 00''$ East, 2450.00 feet to the Southern right of way of Kestral Boulevard; thence traversing the Southern right of way line of Kestral Boulevard the following two courses: North $79^{\circ} 02' 00''$ East, 20.00 feet; thence Easterly on a curve to the right having a radius bearing South $10^{\circ} 58' 00''$ East, 250.00 feet, a central angle of $21^{\circ} 59' 27''$, an arc distance 95.95 feet to the point of beginning containing 0.663 of an acre, more or less.

The above bearings are based on Blackbird Farms, Phase III, Planned Development.

Section 2. Procedures. Each Member who wishes to use the Facilities during any calendar year shall sign a Recreational Facilities Usage Agreement and shall deliver the signed Agreement to the Apartment Owner with that Member's annual usage fee. Upon receipt of the foregoing and confirmation that the Member is in good standing with Association, the Apartment Owner will provide such Member identification permitting access to the Facilities. Membership in good standing with Association and payment of annual usage fees are prerequisites for use of the Facilities by any Member.

Section 3. Use in Common With Others. Members in good standing of Association shall have the right to use the Facilities in common with, and under the same terms and conditions as, tenants of Blackbird Farms Apartments (excepting the requirement of an annual payment, which shall not apply to tenants of Blackbird Farms Apartments). Apartment Owner shall have the right to establish, change and enforce reasonable rules and regulations concerning use of the Facilities, including limitation of the hours during which the Facilities are available for use by Association Members and others and including restrictions on

parking. Except as provided in Section 13 of this Article, the Facilities shall be made available only to residents of Blackbird Farms and their guests and invitees.

Section 4. Term. The covenants in this Article IX shall begin upon execution and recording of this Second Amended Declaration and shall continue as long as the Facilities are available for use by any resident or tenant of Blackbird farms Apartments, but in any event shall extend as least through January 1, 2013.

Section 5. Initial Annual per-Member Payment. Each Member of Association who desires to use any of the Facilities during any calendar year shall be required to pay to Apartment Owner a usage fee. The initial usage fee for any Member of Association shall be \$200.00 per year, payable in advance in one annual installment on or before April 30 of any calendar year. Usage fees shall not be pro-rated for any reason.

Section 6. Adjustments to Usage Fees. Apartment Owner shall have the right, exercisable not more often than annually, to adjust the annual usage fees payable by Members of Association hereunder. However, no annual increase in usage fees shall exceed the increase in the CPI since the date when the then-current usage fee was set. As used herein, the term "CPI" means the "All Items" column of the Revised Consumer Price Index for Urban Wage Earners and Clerical Workers, United States All City Average, published by the Bureau of Labor Statistics, United States Department of Labor.

Section 7. Ownership of Facilities. All Facilities shall remain the property of Apartment Owner at all times.

Section 8. Use of the Facilities. The Facilities shall be used by Members of Association in good standing for social and recreational uses only, and for no other purpose or purposes without Apartment Owner's written consent. No waste or damage shall be committed upon or to the Facilities. The Facilities shall not be used for any unlawful purpose, and no violations of law shall be committed thereon. Members of Association at their own cost and expense shall observe and keep all laws, rules, orders, ordinances and regulations of the federal, state and city governments and any and all of their departments and bureaus and those of any other competent authority relating to the use of the Facilities.

Section 9. Maintenance of the Facilities. Apartment Owner shall keep the Facilities and all mechanical and electrical systems serving same, in good repair. Notwithstanding the foregoing, the cost of repairing any damage to the Facilities caused by any Member of Association, by Apartment Owner, or by any

tenant, resident, guest, invitee or licensee of either of them shall be paid by the person causing such damage.

Section 10. Janitorial Services. Apartment Owner at its expense shall furnish janitorial service to the Facilities.

Section 11. Utilities. Apartment Owner shall provide the Facilities with water, gas, electricity and heating, ventilation and air conditioning service.

Section 12. Non-Liability of Apartment Owner. Apartment Owner shall not be liable in damages or otherwise if the furnishing of any service by it to the Facilities is interrupted by fire, accident, riot, strike, acts of God, or the making of necessary repairs or improvements or other causes beyond the control of Apartment Owner.

Section 13. Access by Apartment Owner. Apartment Owner, Apartment Owner's agents, tenants, guests and invitees of Blackbird Farms Apartments, and prospective tenants, purchasers or mortgagees shall be permitted to inspect, examine and use the Facilities at all times, and Apartment Owner shall have the right to make any repairs to the Facilities which Apartment Owner may deem necessary.

Section 14. Entire Obligation. Apartment Owner has not made any statement, promise or agreement or taken upon itself any engagement whatever verbally or in writing that conflicts with the terms of this Article or in any way modifies, varies, alters, enlarges or invalidates any of the provisions of this Agreement, and no obligation of Apartment Owner shall be implied in addition to the obligations stated in this Article.

Section 15. Successors and Assigns. No Member of Association shall have the right to assign, encumber, or in any manner to transfer such Member's right to use the Facilities, except to the purchaser of such Member's Lot. Subject to the foregoing sentence, this Agreement shall be binding upon and inure to the benefit of Apartment Owner and Members of Association and their respective successors and assigns, and the obligations of the Apartment Owner and of Members of Association shall be covenants running with the land owned by them in Blackbird Farms.

Section 16. Relationship of the Parties. Nothing in this Article shall be deemed or construed as creating the relationship of principal and agent, partnership, joint venture or landlord and tenant between Apartment Owner and the Association or any Member of Association.

ARTICLE X

POND MAINTENANCE

Section 1. Shoreline Maintenance. Regular mowing, fertilizing, weed control, leaf and trash removal, cleanup and other surface maintenance with respect to the shoreline of Blackbird Pond ("Shoreline Maintenance") shall be provided as follows: Apartment Owner shall provide Shoreline Maintenance on that portion of the shoreline and embankment areas of Blackbird Pond beginning at the southeast corner of Lot 192, thence westerly around the Blackbird Pond shoreline adjoining McCormick Road, Lot 189, the pool and clubhouse facilities and the wetlands area to the northwest corner of Lot 99. Association shall provide Shoreline Maintenance on that portion of the shoreline and embankment areas of Blackbird Pond beginning at the northwest corner of Lot 99 and continuing to the southeast corner of Lot 192.

Section 2. Pond Maintenance. Apartment Owner shall pay seventy-five percent (75%) of the cost of all required Blackbird Pond maintenance other than Shoreline Maintenance, and Association shall pay twenty-five percent (25%) of the cost of all required Blackbird Pond maintenance other than Shoreline Maintenance. Any tort liability arising out of Blackbird Pond or the use thereof shall be divided in the above percentages between Apartment Owner and the Association. Insurance to cover such potential liability shall be maintained by each party at all times, with coverage limits of at least One Million Dollars (\$1,000,000). Notwithstanding the foregoing, the cost of repairing any damage to Blackbird Pond or to its shoreline caused by any Member of Association, by Apartment Owner, or by any tenant, resident, guest, invitee or licensee of either of them shall be paid by the person causing such damage.

Section 3. Maintenance Decisions. Neither Apartment Owner nor Association shall have any obligation to pay for Blackbird Pond maintenance described in Section 2 of this Article unless and until both parties have approved such maintenance in writing; provided, that even in the absence of such agreement the parties shall pay their respective portions of pond maintenance costs to the extent required by any court or any state or local governmental entity having jurisdiction thereof.

Section 4. Term. The term of the covenants in this Article shall begin on the date this Second Amended Declaration is executed and recorded, and shall extend as long as Blackbird Pond exists upon the Real Estate.

Section 5. Arbitration. If any dispute arising under this Article cannot be resolved between the parties, the sole method for resolving the dispute shall be final and binding arbitration

in Lafayette, Indiana pursuant to the rules of the American Arbitration Association with one arbitrator selected by each party, and a third arbitrator selected by the two arbitrators so selected. All costs and expenses of the arbitration, including actual attorney's fees, shall be allocated among the parties according to the arbitrators' discretion; provided, that if the dispute arises out of either party's nonpayment of amounts owed for agreed maintenance, the prevailing party shall be entitled to its attorney's fees in addition to any other arbitration award. The arbitrators' award may be confirmed and entered as a final judgment in any court of competent jurisdiction and enforced accordingly.

Section 6. Waiver. The waiver by either party of any term, covenant, or condition in this Article in one instance shall not be deemed to be a waiver of such term, covenant or condition in the future, or of any subsequent breach thereof or any other term, covenant or condition of this Article.

Section 7. Notices. All notices and demands which may be or are required to be given by either party to the other under this Article shall be in writing and shall be hand delivered or sent by United States mail, first class postage prepaid, addressed to Association in care of its Registered Agent or addressed to Apartment Owner at its rental office, or to such other person or to such other place as Association or Apartment Owner may from time to time designate in writing to the other.

Section 8. Entire Agreement. Neither Association nor Apartment Owner has made any statement, promise or agreement or taken upon itself any engagement whatever verbally or in writing that conflicts with the terms of this Article or in any way modifies, varies, alters, enlarges or invalidates any of the provisions of this Article, and no obligation of Association or Apartment Owner shall be implied in addition to the obligations stated in this Article.

Section 9. Successors and Assigns. Except as limited herein, this Article shall be binding upon and inure to the benefit of Association and Apartment Owner and their respective successors and assigns, and the obligations of Association and Apartment Owner shall be covenants running with the land owned by them in Blackbird Farms.

Section 10. Relationship of the Parties. Nothing in this Article shall be deemed or construed as creating the relationship of principal and agent, partnership or joint venture between Association and Apartment Owner, it being understood and agreed that no provision of this Article nor any acts of Apartment Owner or Association shall be deemed to create any relationship between the parties other than the relationship of independent contractors.

®

ARTICLE X

GENERAL PROVISIONS

Section 1. Acceptance and Ratification. All present and future Owners, Mortgagees, tenants and occupants of the Lots shall be subject to and shall comply with the provisions of this Declaration, the Articles of Incorporation, and the Bylaws incorporated herein by reference, and the rules and regulations as adopted by the Board of Directors as each may be amended from time to time. The acceptance of a deed of conveyance or the act of occupancy of any Lot shall constitute an agreement that the provisions of this Declaration, the Articles of Incorporation, the Bylaws, and rules and regulations, as each may be amended or supplemented from time to time, are accepted and ratified by such Owner, tenant or occupant, and all such provisions shall be covenants running with the land and shall be binding on any person having at any time any interest or estate in a Lot or the Real Estate as though such provisions were recited and stipulated at length in each and every deed, conveyance, mortgage or lease thereof. All persons, corporations, partnerships, trusts, associations, or other legal entities who may occupy, use, enjoy or control a Lot or Lots or any part of the Real Estate in any manner shall be subject to the Declaration, the Articles of Incorporation, the Bylaws, and the rules and regulations applicable thereto as each may be amended or supplemented from time to time.

Section 2. Negligence. Each Owner shall be liable for the expense of any maintenance, repair or replacement rendered necessary by his negligence or by that of any member of his family or his or their guests, employees, agents or lessees to the extent that such expense is not covered by the proceeds of insurance carried by the Association.

Section 3. Costs and Attorneys' Fees. In any proceeding arising because of failure of an Owner to make any payments required to comply with any provision of this Declaration, the Articles of Incorporation, the Bylaws, or the rules and regulations adopted pursuant thereto as each may be amended from time to time, the Association shall be entitled to recover its reasonable attorneys' fees incurred in connection with such default or failure.

Section 4. Waiver. No Owner may exempt himself from liability for his contribution toward the Common Expenses by waiver of the use or enjoyment of any of the Common Area or by abandonment of his Single-Family Lot, or by contract to provide goods or services to the Association until after the first annual meeting after the Applicable Date.

®

Section 5. Severability Clause. The invalidity of any covenant, restriction, condition, limitation or other provision of this Declaration, the Articles or the Bylaws, shall not impair or affect in any manner the validity, enforceability or effect of the rest of this Declaration, the Articles, or the Bylaws, and each shall be enforced to the greatest extent permitted by law.

Section 6. Pronouns. Any references to the masculine, feminine or neuter gender herein shall, unless the context clearly requires to the contrary, be deemed to refer to and include all genders. Use of the singular shall include and refer to the plural and vice versa as appropriate.

Section 7. Interpretation. The captions and titles of the various articles, sections or subsections of this Declaration are inserted herein for ease and convenience of reference only and shall not be used as an aid in interpreting or construing this Declaration or any provision hereof.

Section 8. Enforcement. The Association, any Owner, and the City of West Lafayette shall have the right to enforce, by any proceeding at law or in equity, all restrictions, conditions, covenants, reservations, liens and charges now or hereafter imposed by the provisions of this Declaration. The enforcing party shall be entitled to recovery of its costs and expenses of enforcement, including attorneys' fees, in any such enforcement action, provided that the Association or other enforcing party prevails in such action. Failure to enforce any covenant or restriction herein contained shall in no event be deemed a waiver of the right to do so thereafter.

Section 9. Effect of Second Amended Declaration. This Second Amended Declaration of Covenants, Conditions and Restrictions for Blackbird Farms Planned Development replaces, supercedes and renders null and void the Declaration of Covenants, Conditions and Restrictions for Blackbird Farms Planned Development heretofore executed by Declarant and recorded with the Tippecanoe County Recorder on February 2, 1990 as document number 90-01518 and the First Amended Declaration of Covenants, Conditions and Restrictions for Blackbird Farms Planned Development heretofore executed by Declarant and recorded with the Tippecanoe County Recorder on July 31, 1992 as document number 92-16830.

Section 10. Duration of Restrictive Covenants. Except as otherwise provided herein, the foregoing covenants (or restrictions) are to run with the land and shall be binding on all parties and all persons claiming under them until January 1, 2001, at which time said covenants (or restrictions) shall be automatically extended for successive periods of ten (10) years unless by vote of a majority of the ten owners of the building sites covered by these covenants (or restrictions), it is agreed to change such covenants (or restrictions) in whole or in part. ®

IN WITNESS WHEREOF, the undersigned, being the Declarant herein, has caused this Second Amended Declaration of Covenants, Conditions and Restrictions for Blackbird Farms Planned Development to be executed by Joseph A. Bonner, its President this 20th day of April, 1994.

LAFAYETTE BANK & TRUST COMPANY

By: Joseph A. Bonner
Joseph A. Bonner, President

ATTEST:

Robert J. Weeder
Robert J. Weeder,
Executive Vice President

STATE OF INDIANA)
) SS:
COUNTY OF TIPPECANOE)

Before me, the undersigned Notary Public, personally appeared Lafayette Bank & Trust Company, by Joseph A. Bonner, its President, and Robert J. Weeder, its Executive Vice President, who for and on behalf of said corporation acknowledged the execution of the foregoing instrument and swore to the truth of the statements made therein.

Witness my hand and Notarial Seal this 20th day of April, 1994.

Margaret M. Owen
Notary Public

My Commission Expires: Sept. 16, 1995

County of Residence: Tippecanoe

U.Z.O. ADMINISTRATIVE OFFICER APPROVAL

The undersigned West Lafayette City Engineer, as Administrative Officer, pursuant to Section 5.6(d) of the Unified Zoning Ordinance of Tippecanoe County, does hereby APPROVE the foregoing Second Amended Declaration and all covenants stated therein as a MINOR MODIFICATION of the previously approved



CHICAGO TITLE

Blackbird Farms Planned Development reflected in the Final Detailed Construction Plans and associated Declaration of Covenants, Conditions and Restrictions for Blackbird Farms Planned Development Phase One, Blackbird Farms Planned Development Phase Three and Replat of Lot 2 in Simmons Subdivision, and Blackbird Farms Planned Development Phase Two Section One and Replat of Lot 192 in Phase Three, as recorded in Plat Cabinet AA-118, Document No. 90-03389, on March 19, 1990, Plat Cabinet AA-119, Document No. 90-03390, on March 19, 1990, and Plat Cabinet AA-129, Document No. 91-20702, on December 20, 1991, respectively, in the Office of the Recorder of Tippecanoe County, Indiana. This foregoing Second Amended Declaration also having been accepted and approved for Blackbird Farms Planned Development Phase Two Section Two on rezoning Petition Z-1547 by action of the Tippecanoe County Area Plan Commission on March 16, 1994, and action of the Common Council of West Lafayette, Indiana, on April 5, 1994, it is now approved by this Administrative Officer on the 20 day of April, 1994.

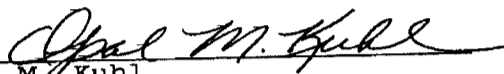
Opal M. Kuhl,
Administrative Officer,
City Engineer of
City of West Lafayette

This instrument prepared by:
STUART & BRANIGIN
By: Erik D. Spykman

32944.1



- 33 -

CHICAGO TITLE

EXHIBIT A
Legal Description of Real Estate

The North half of the Northwest Quarter of Section thirteen (13), Township Twenty-three (23) North, Range five (5) West, containing Eighty (80) acres, more or less.

Also, Lot 2 in Simmons Subdivision as recorded in Plat Book 14, Page 47, Slide A-53 in the Office of the Recorder, Tippecanoe County, Indiana, containing 0.92 acres, more or less.

32944.1



-34-

CHICAGO TITLE

Plan Develop

9408552

AA-138



CHICAGO TITLE

RESOLUTION PD 94-1

WHEREAS Preliminary Plans for *Blackbird Farms Planned Development, Phase 2, Section 2* are approved as part of Z-1547 with 9 conditions attached;

WHEREAS the Area Plan Commission Staff finds that all conditions have been met;

WHEREAS UZO 5.6(d) states that minor modifications approvable by the Administrative Officer "shall not include any increase in density, any lessening of aesthetic treatment, any alteration of frontage or general building location, any change in type of use or any change in access points"; and

WHEREAS the Area Plan Commission Staff finds these Final Detailed Plans to be consistent with the Approved Preliminary Planned Development as adopted and passed by the West Lafayette Common Council on April 4, 1994;

NOW THEREFORE BE IT RESOLVED that the Tippecanoe County Area Plan Commission, after examination of the Final Detailed Plans submitted for *Blackbird Farms Planned Development, Phase 2, Section 2*, does hereby find them to be consistent with the Approved Preliminary Planned Development (Z-1547) as adopted and passed by the West Lafayette Common Council.

Mesley A. Arch

PRESIDENT

Robert A. Muehlen

SECRETARY

April 20, 1994

DATE

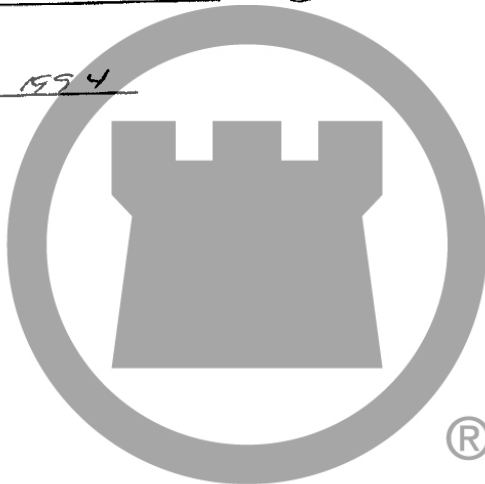

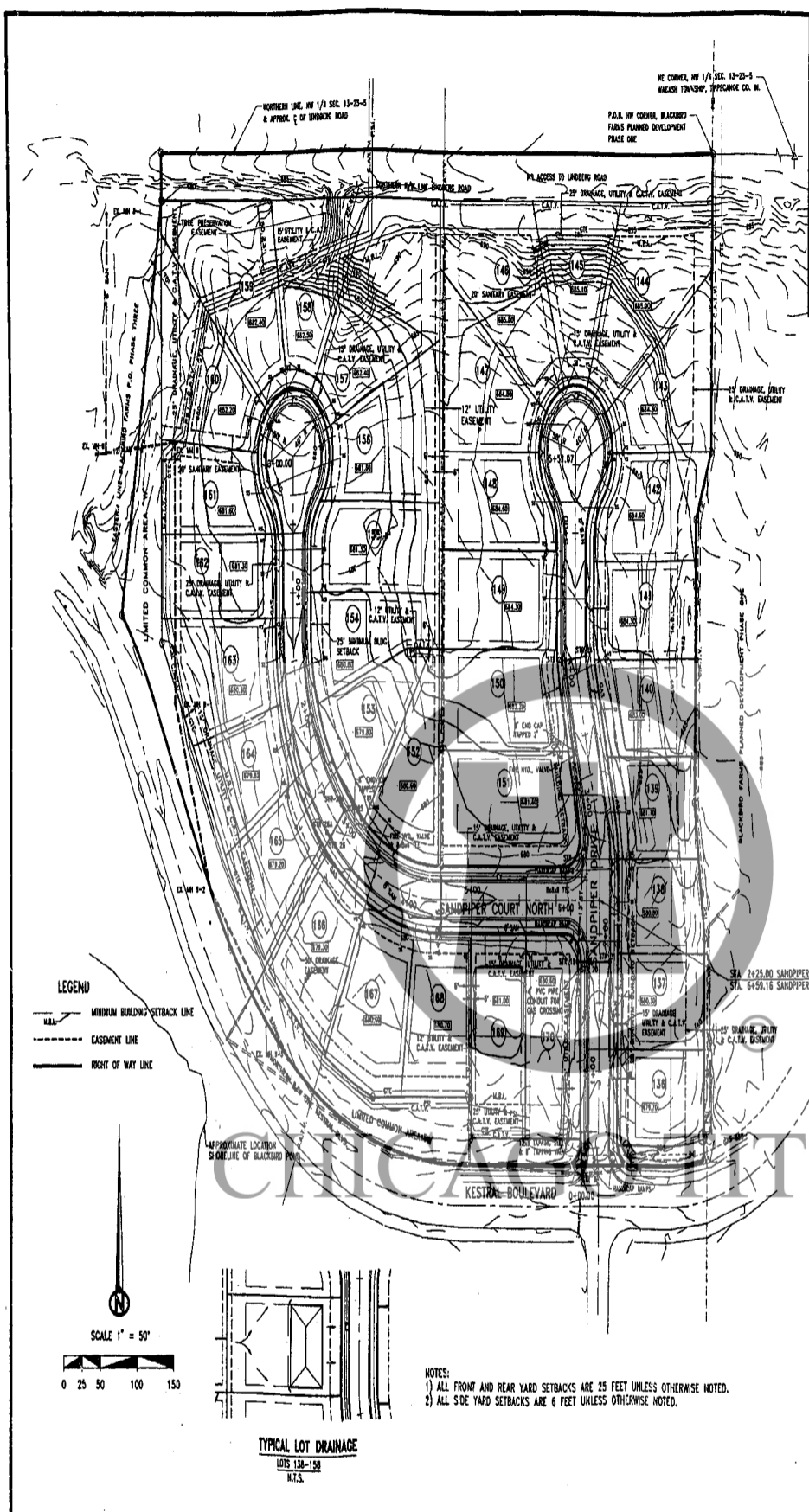

LEGEND

○	EXIST. MANHOLE	---	C.A.T.V.	---	EXIST. CABLE TV
□	EXIST. INLET	---	PSI	---	EXIST. UNDERGROUND PSI LINE
⊙	EXIST. FIRE HYDRANT	---	ST	---	EXIST. STORM SEWER
⊕	EXIST. GATE VALVE	---	SA	---	EXIST. SANITARY SEWER
⊖	EXIST. POWER POLE	---	W	---	EXIST. WATER LINE
⊗	EXIST. GUY WIRE	---	GAS	---	EXIST. GAS LINE
⊘	PROP. MANHOLE	---	SA	---	PROP. SANITARY LATERAL SERVICE
⊙	PROP. INLET	---	SA	---	PROP. WATER SERVICE
⊕	PROP. FIRE HYDRANT W/ GATE VALVE	---	ST	---	PROP. SANITARY SEWER
⊖	PROP. GATE VALVE	---	W	---	PROP. STORM SEWER
⊗	PROP. BLOW-OFF VALVE	---	W	---	PROP. WATER LINE
⊘	PROP. GAS VALVE	---	PSI	---	PROP. UNDERGROUND PSI LINE
⊙	EXIST. FENCE	---	GAS	---	PROP. GAS LINE
883.00	PROP. F.M. PAD ELEVATION	---	C.A.T.V.	---	PROP. CABLE TV
883.00	EXIST. CONTOUR ELEVATION	---	GTE	---	PROP. TELEPHONE
883.00	PROP. CONTOUR ELEVATION	---	TR	---	PROP. PAD-MOUNTED TRANSFORMER
---	EXIST. TELEPHONE	---	TR	---	EXIST. PAD-MOUNTED TRANSFORMER

SCN = SANDPIPER COURT NORTH SD = SANDPIPER DRIVE

STR. NO.	LOCATION	ELEVATION		PIPE LENGTH (FT)	PIPE SIZE (IN)	PIPE SLOPE (%)	STR. TYPE	CASTING
		TR.	BL.					
25A	2404.35, 14.5071 SCN	877.14	88.00	12	12	2.95	C.B. INLET 7' x 7'	8-2247Y
25	2404.82, 14.5071 SCN	877.13	88.00	25.00	12	0.44	C.B. INLET 7' x 7'	8-2247Y
25A	2401.23, 14.5071 SCN	877.14	88.00	12	12	2.80	C.B. INLET 7' x 7'	8-2247Y
25	2404.81, 14.5071 SCN	877.13	88.00	17.73	12	1.00	C.B. INLET 7' x 7'	8-2247Y
EXIST. # 1	2404.82, 18.2371 SD	878.43	88.00	0.00	12	0.00		
24	2406.20, 14.5071 SD	880.84	88.00	12	12	0.44	C.B. INLET 7' x 7'	8-2247Y
23	2406.20, 14.5071 SD	880.84	88.00	15.33	12	0.44	C.B. INLET 7' x 7'	8-2247Y
22	2431.26, 15.4471 SD 2433.71, 16.1271 SD	878.88 880.84	88.00	71.39	12	0.44	C.B. INLET 7' x 7'	8-2247Y
21	1400.00, 14.5071 SD	878.88	88.00	25.80	12	0.44	C.B. INLET 7' x 7'	8-2247Y
20	1400.00, 14.5071 SD	878.88	88.00	13.00	12	0.44	C.B. INLET 7' x 7'	8-2247Y
18	1400.00, 28.5071 SD	878.88	88.00	15.84	18	0.24	MANHOLE TYPE "E" 7' x 7'	8-1770CH
EXIST. # 2	9425.71, 22.5471 SD	878.88	88.00	0.00	12	0.00		EXIST. 18" STAB-OUT

- STRUCTURE TABLE NOTES:**
- 1) ALL DISTANCES MEASURED TO CENTER OF STRUCTURE AT BACK OF CURB OR TO CENTER OF MANHOLE.
 - 2) ALL CATCH BASINS TO BE LOCALLY DERESSED 1/2" BELOW GUTTERLINE.

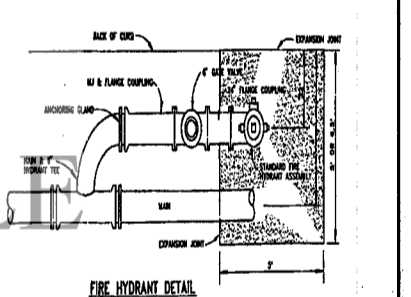

SITE GRADING & UTILITY PLAN

BLACKBIRD FARMS, PHASE TWO, SECTION TWO

DATE	2-14-82	SHEET NO.	2
BY	J.A.S.		
CHECKED BY	J.A.S.	OF	13
DATE	2-14-82		
SCALE	AS SHOWN	TECH. SCHULTE & ASSOCIATES, P.C. CIVIL ENGINEERS-LAND SURVEYORS 802 Columbia Street Lafayette, Indiana 47901 Phone: (317) 742-4242 Fax: (317) 425-8835	

- NOTES:**
- 1) ALL FRONT AND REAR YARD SETBACKS ARE 25 FEET UNLESS OTHERWISE NOTED.
 - 2) ALL SIDE YARD SETBACKS ARE 6 FEET UNLESS OTHERWISE NOTED.

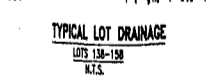

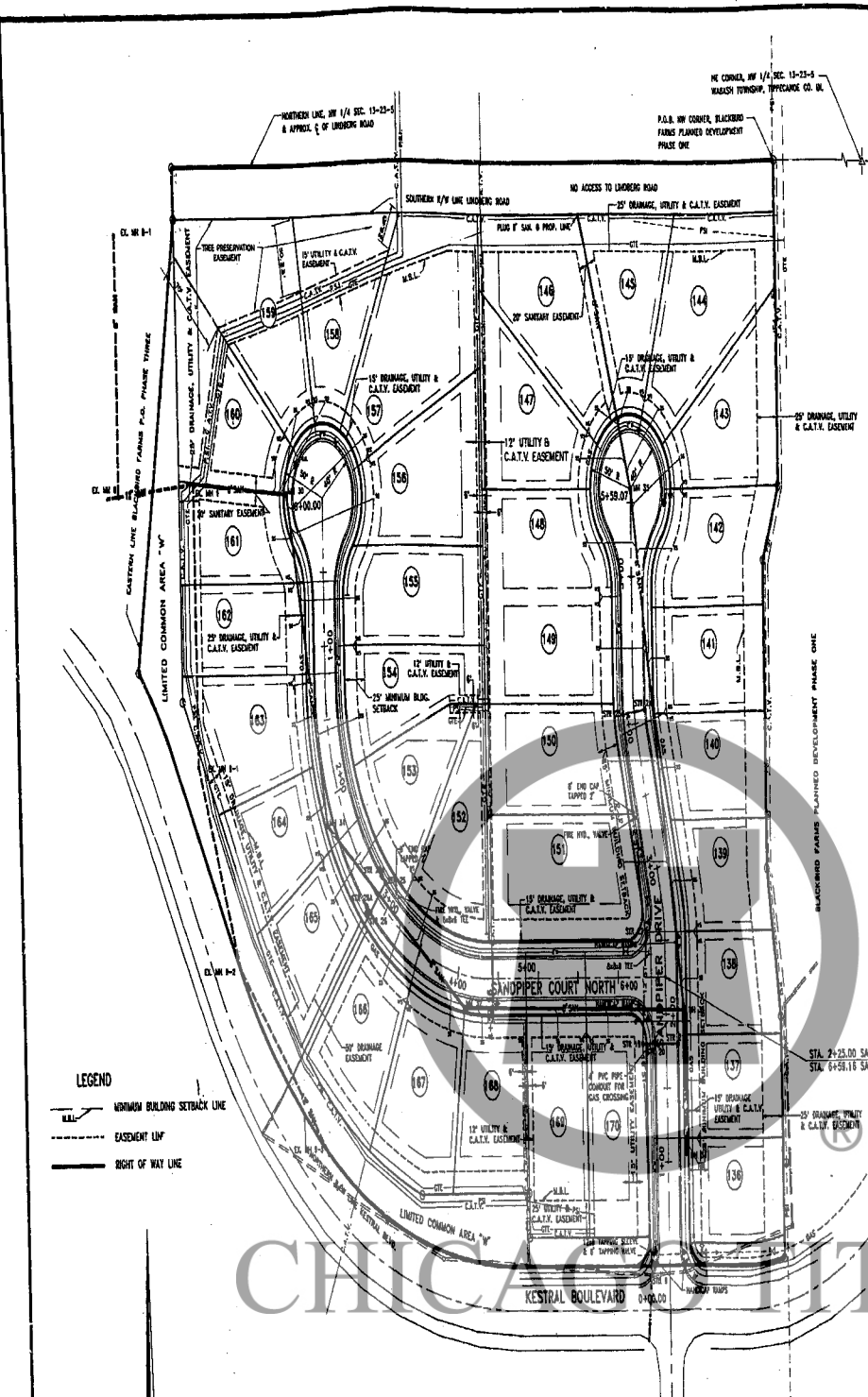

LEGEND

○	EXIST. MANHOLE	---	C.A.T.V.	---	EXIST. CABLE TV
□	EXIST. INLET	---	PSI	---	EXIST. UNDERGROUND PSI LINE
⊕	EXIST. FIRE HYDRANT	---	ST	---	EXIST. STORM SEWER
⊕	EXIST. GATE VALVE	---	W	---	EXIST. SANITARY SEWER
⊕	EXIST. POWER POLE	---	W	---	EXIST. WATER LINE
⊕	EXIST. GUY WIRE	---	GAS	---	EXIST. GAS LINE
⊕	PROP. MANHOLE	---	W	---	PROP. SANITARY LATERAL SERVICE
⊕	PROP. INLET	---	W	---	PROP. WATER SERVICE
⊕	PROP. FIRE HYDRANT W/ GATE VALVE	---	W	---	PROP. SANITARY SEWER
⊕	PROP. GATE VALVE	---	ST	---	PROP. STORM SEWER
⊕	PROP. BLOW-OFF VALVE	---	W	---	PROP. WATER LINE
⊕	PROP. GAS VALVE	---	PSI	---	PROP. UNDERGROUND PSI LINE
⊕	EXIST. TRENCH	---	GAS	---	PROP. GAS LINE
⊕	PROP. FIN. PAD ELEVATION	---	C.A.T.V.	---	PROP. CABLE TV
⊕	EXIST. CONTOUR ELEVATION	---	GTE	---	PROP. TELEPHONE
⊕	PROP. CONTOUR ELEVATION	---	W	---	PROP. PAD-MOUNTED TRANSFORMER
⊕	EXIST. TELEPHONE	---	⊕	---	EXIST. PAD-MOUNTED TRANSFORMER
⊕	STREET LIGHT	---	⊕	---	

PROJECT UTILITIES:	APPROVED BY:	DATED:
PSI ENERGY, INC. P.O. BOX 120 LAFAYETTE, INDIANA 47902 PHONE: (317) 742-6800	<i>[Signature]</i>	3/21/99
GTE NORTH P.O. BOX 1640 LAFAYETTE, INDIANA 47902 PHONE: (317) 423-5533	<i>[Signature]</i>	3/21/99
DIMENSION CABLE P.O. BOX 4609 LAFAYETTE, INDIANA 47903 PHONE: (317) 447-8806	<i>[Signature]</i>	3/21/99
INDIANA GAS COMPANY, INC. P.O. BOX 6169 LAFAYETTE, INDIANA 47903 PHONE: (317) 449-5669	<i>[Signature]</i>	3/21/99
WEST LAFAYETTE WATER CO., INC. P.O. BOX 2359 WEST LAFAYETTE, INDIANA 47906 PHONE: (317) 453-5531	<i>[Signature]</i>	3/21/99

LEGEND

---	MINIMUM BUILDING SETBACK LINE
---	EASEMENT LINE
---	RIGHT OF WAY LINE

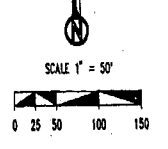

NOTES:
 1) ALL FRONT AND REAR YARD SETBACKS ARE 25 FEET UNLESS OTHERWISE NOTED.
 2) ALL SIDE YARD SETBACKS ARE 6 FEET UNLESS OTHERWISE NOTED.

REVISION				DATE		BY	

UTILITY COORDINATION PLAN					
BLACKBIRD FARMS, PHASE TWO, SECTION TWO					
DATE:	3/21/99		3		
BY:	R.A.L.			OF	
DATE:	3/21/99				13
BY:	R.A.L.				

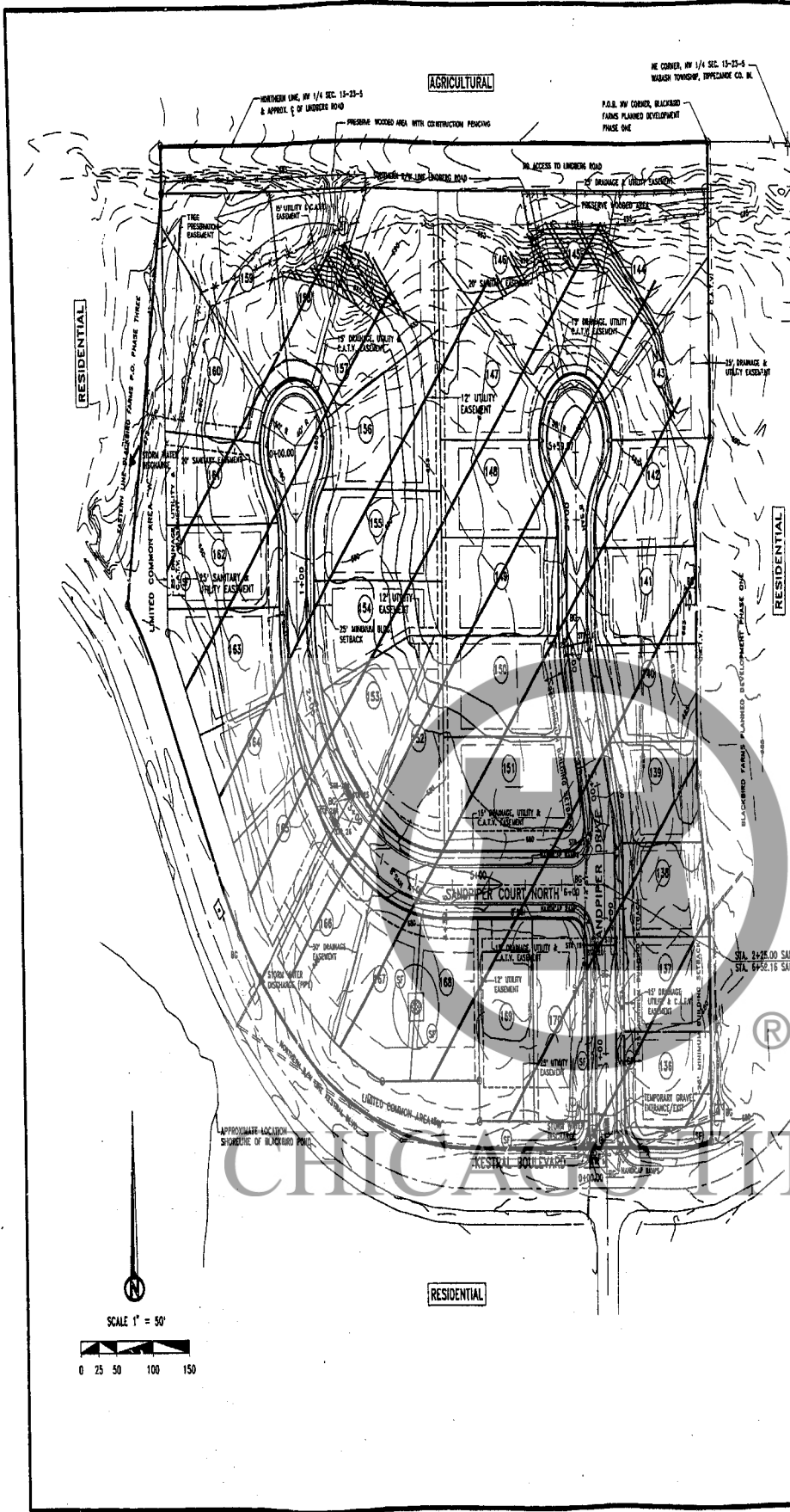

LEGEND

○	EXIST. MANHOLE	---	C.A.T.V.	---	EXIST. CABLE TV
□	EXIST. INLET	---	PSI	---	EXIST. UNDERGROUND PSI LINE
○	EXIST. FIRE HYDRANT	---	ST	---	EXIST. STORM SEWER
○	EXIST. GATE VALVE	---	ST	---	EXIST. SANITARY SEWER
○	EXIST. POWER POLE	---	W	---	EXIST. WATER LINE
○	EXIST. GUY WIRE	---	GAS	---	EXIST. GAS LINE
○	PROP. MANHOLE	---	SAW	---	PROP. SANITARY LATERAL SERVICE
○	PROP. INLET	---	SAW	---	PROP. WATER SERVICE
○	PROP. FIRE HYDRANT W/ GATE VALVE	---	ST	---	PROP. SANITARY SEWER
○	PROP. GATE VALVE	---	ST	---	PROP. STORM SEWER
○	PROP. BLOW-OFF VALVE	---	W	---	PROP. WATER LINE
○	PROP. GAS VALVE	---	PSI	---	PROP. UNDERGROUND PSI LINE
○	EXIST. FENCE	---	GAS	---	PROP. GAS LINE
○	PROP. FIN. PAD ELEVATION	---	C.A.T.V.	---	PROP. CABLE TV
○	EXIST. CONTOUR ELEVATION	---	GTE	---	PROP. TELEPHONE
○	PROP. CONTOUR ELEVATION	---	II	---	PROP. PAD-MOUNTED TRANSFORMER
○	GTE	---	II	---	EXIST. PAD-MOUNTED TRANSFORMER
○	8400 TELEPHONE	---		---	

- BC BLOCK AND GRAVEL CURB
INLET PROTECTION
- BC BLOCK AND GRAVEL DROP
INLET PROTECTION
- SF SILT FENCE (SEDIMENT FENCE)
- TOPSOIL (SALVAGE AND UTILIZATION)
- PS PERMANENT SEEDING
- SR SURFACE ROUGHENING

NOTE:
 EROSION CONTROL MEASURES SHALL COMPLY WITH ILL. REG. 15-3 (PRE-19) AND THE NATIONAL HANDBOOK FOR EROSION CONTROL IN DEVELOPING AREAS. THE SILENT EROSION PLAN HAS BEEN SUBMITTED TO THE ILLINOIS DEPARTMENT OF TRANSPORTATION AND SHALL BE REVIEWED AND APPROVED BY THE ILLINOIS DEPARTMENT OF TRANSPORTATION. THESE CONSTRUCTION AND PROTECTION SHALL COMPLY WITH THE NATIONAL HANDBOOK FOR EROSION CONTROL IN DEVELOPING AREAS.

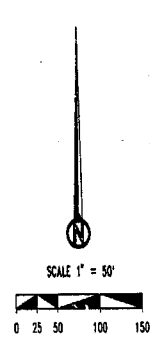

CHICAGO TITLE

REVISION			NO.		DATE		DESCRIPTION	

EROSION & SEDIMENT CONTROL PLAN			
BLACKBIRD FARMS, PHASE TWO, SECTION TWO			
DATE:	3-14-94	SCALE:	AS SHOWN
DRAWN BY:	J.S.	CHECKED BY:	J.S.
DESIGNED BY:	J.S.	APPROVED BY:	J.S.
DATE:	3-14-94	SCALE:	AS SHOWN

TS TRESA SCHULTE & ASSOCIATES, P.C. CONSULTING ENGINEERS 802 Columbia Street Lafayette, Indiana 47901 Phone: (317) 342-6212 Fax: (317) 428-5522	PROJECT NO.	4
	SHEET NO.	13

PLANT LIST

QTY.	TYPE	SIZE
5	RED OAK (QUERCUS RUBRA)	3" CAL
4	RED MAPLE (ACER RUBRUM)	3" CAL
6	JAPANESE FL. CRAB (MALUS FLOREBUNDA)	2" CAL
25	ARBOREOUS VIBURNUM (VIBURNUM DENTATUM)	24"
52	SEAGREEN JUNIPER	18" CAL
12	NORWAY SPRUCE (PICEA ABIES)	5'-6"
8	WHITE FERN (FERNS STERENS)	5'-4"
6	COLORADO BLUE SPRUCE (PICEA PICEENS 'HOOPERI')	5'-4"
3	TALL JUNIPERS	4'-5"

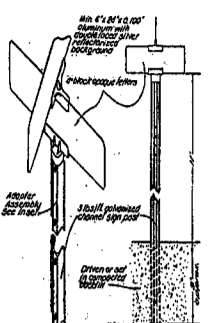
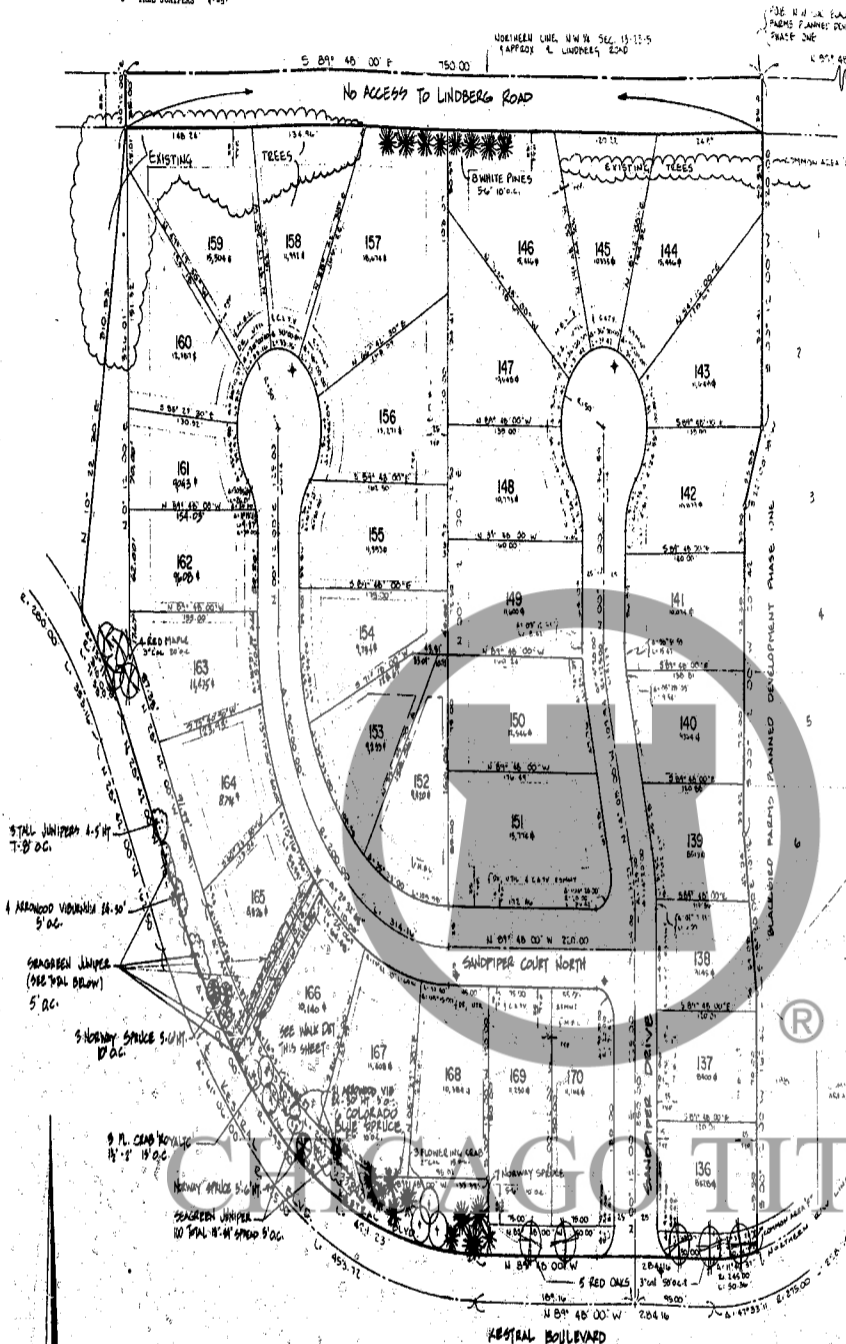

STREET SIGN DETAIL
NO SCALE

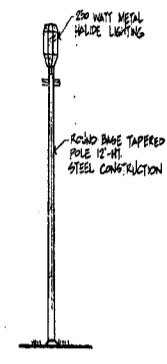

STREET LAMP DETAIL
NO SCALE

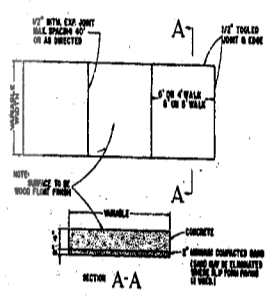

SECTION A-A

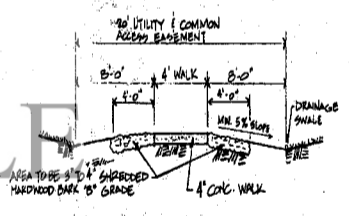

WALK DETAIL
NO SCALE

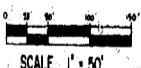

SCALE 1" = 50'

◆ = STREET LIGHT

REVISIONS		LANDSCAPE PLAN	
NO.	DATE	BY	REVISION
PROJECT		BLACKBIRD FARMS, PHASE TWO, SECTION TWO	
DATE	10-11-04	 TREEN, SCHMITT & ASSOCIATES, P.C. CIVIL ENGINEERS-LAND SURVEYORS 302 Columbia Street Chicago, Illinois 60601 Phone: (312) 742-4342 Fax: (312) 429-3335	SHEET NO. 6 OF 13
SCALE	1" = 50'		
DESIGNER	J.C.W.		
CHECKED	J.C.W.		

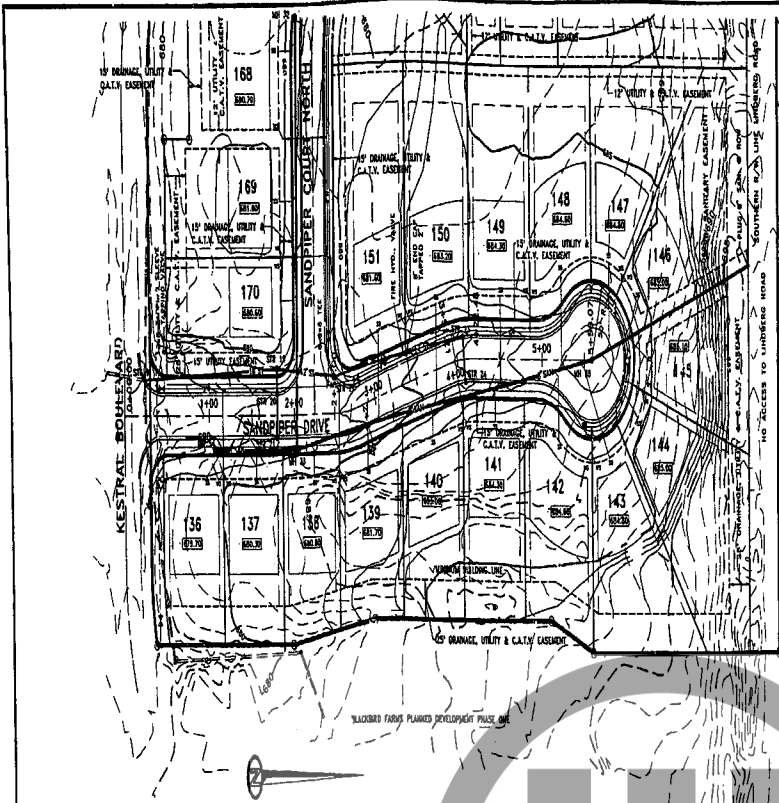

LEGEND

○	EXIST. MANHOLE	====SF====	EXIST. STORM SEWER
□	EXIST. INLET	====SAN====	EXIST. SANITARY SEWER
⊕	EXIST. FIRE HYDRANT	---	EXIST. WATER LINE
⊕	EXIST. GATE VALVE	---	PROP. SANITARY LATERAL SERVICE
⊕	EXIST. POWER POLE	---	PROP. WATER SERVICE
⊕	EXIST. GUY WIRE	---	PROP. SANITARY SEWER
⊕	PROP. MANHOLE	---	PROP. STORM SEWER
⊕	PROP. INLET	---	PROP. WATER LINE
⊕	PROP. FIRE HYDRANT W/ GATE VALVE	---	PROP. ELECTRIC ROUTE
⊕	PROP. GATE VALVE	---	PROP. CABLE ROUTE
⊕	PROP. BLOW-OFF VALVE	---	PROP. TELEPHONE ROUTE
⊕	EXIST. FENCE	---	EXIST. CENTER PAVED DITCH
⊕	PROP. FIN. PAD ELEVATION	---	EASEMENT LINE
		---	VARIOUS BUILDING LINE

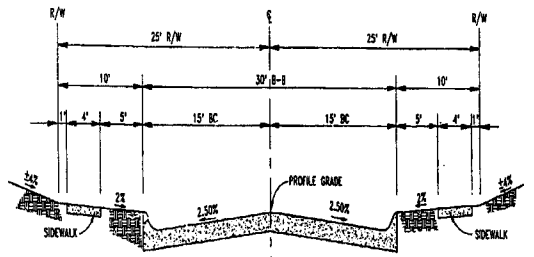

TYPICAL STREET SECTION
N/S

PLAN
SCALE: 1"=50'

PROFILE
SCALE: 1"=5' VERT.
1"=5' HORIZ.

NOTES:
1) ALL FRONT AND REAR YARD SETBACKS ARE 25 FEET UNLESS OTHERWISE NOTED.
2) ALL SIDE YARD SETBACKS ARE 6 FEET UNLESS OTHERWISE NOTED.

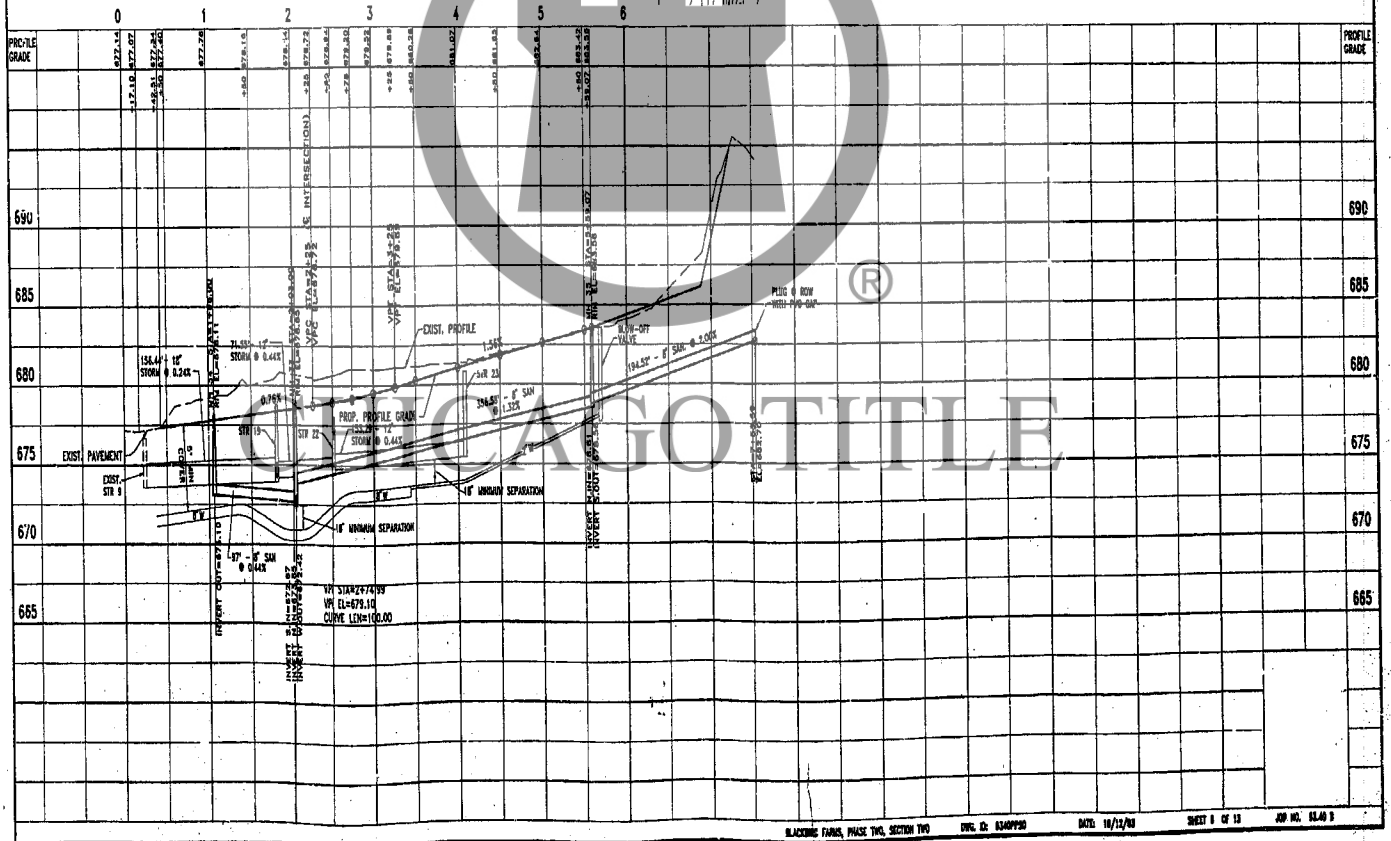

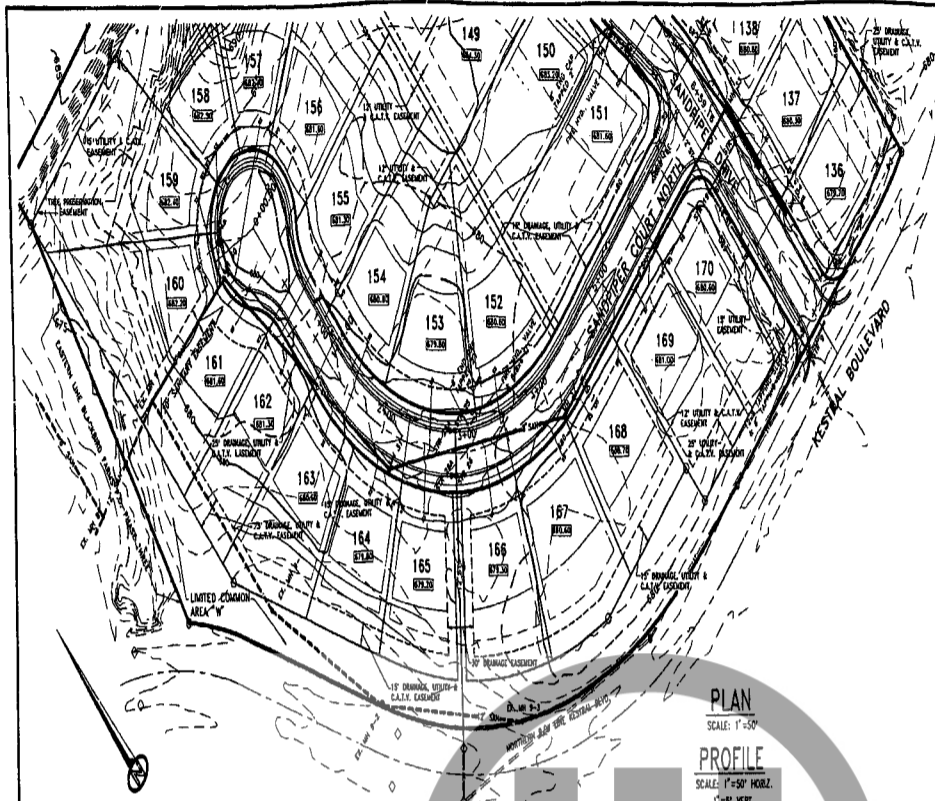

LEGEND

○	EXIST. MANHOLE	====	EXIST. STORM SEWER
□	EXIST. INLET	==S==	EXIST. SANITARY SEWER
◇	EXIST. FIRE HYDRANT	---	EXIST. WATER LINE
⊕	EXIST. GATE VALVE	---	PROF. SANITARY LATERAL SERVICE
⊖	EXIST. POWER POLE	---	PROF. WATER SERVICE
⊙	EXIST. GUY WIRE	---	PROF. SANITARY SEWER
⊕	PROP. MANHOLE	---	PROF. STORM SEWER
⊖	PROP. INLET	---	PROF. WATER LINE
⊕	PROP. FIRE HYDRANT W/ GATE VALVE	---	PROF. ELECTRIC ROUTE
⊖	PROP. GUY WIRE	---	PROF. CABLE ROUTE
⊕	PROP. GATE VALVE	---	PROF. TELEPHONE ROUTE
⊖	PROP. BLOW-OFF VALVE	---	EXIST. CENTER PAVED DITCH
⊕	EXIST. FENCE	---	EASEMENT LINE
⊖	PROP. FIN. PAD ELEVATION	---	MINIMUM BUILDING LINE

NOTES:
 1) ALL FRONT AND REAR YARD SETBACKS ARE 25 FEET UNLESS OTHERWISE NOTED.
 2) ALL SIDE YARD SETBACKS ARE 6 FEET UNLESS OTHERWISE NOTED.

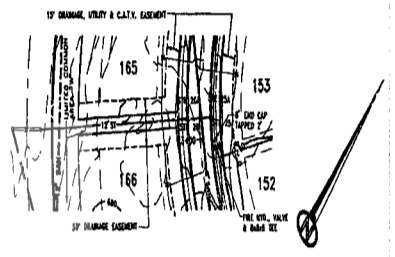

PLAN
 SCALE: 1"=50'
PROFILE
 SCALE: 1"=50' HORIZ.
 1"=9' VERT.

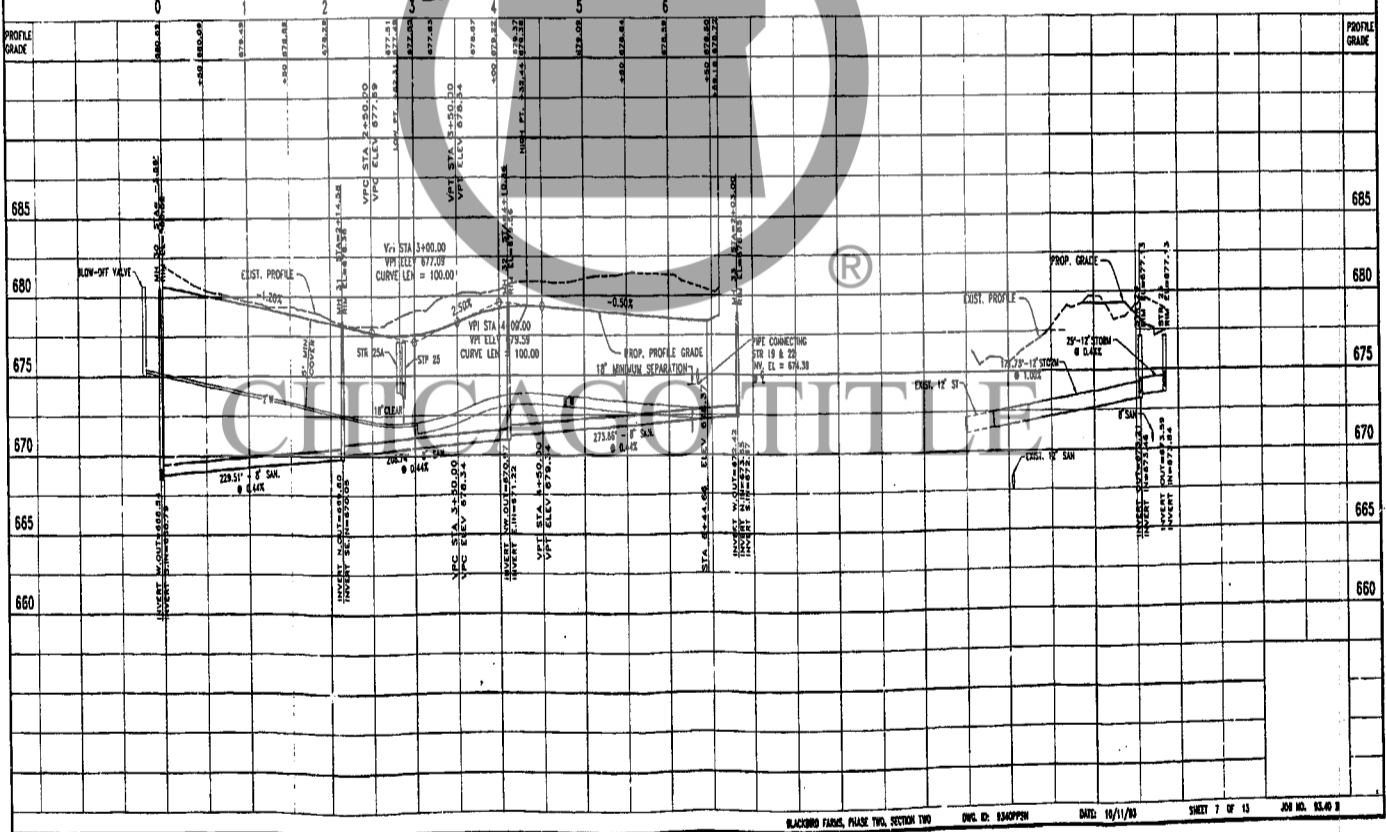

LEGEND

○	EXIST. MANHOLE	====ST====	EXIST. STORM SEWER
□	EXIST. INLET	====SAN====	EXIST. SANITARY SEWER
⊕	EXIST. FIRE HYDRANT	---	EXIST. WATER LINE
⊕	EXIST. GATE VALVE	---	PROP. SANITARY LATERAL SERVICE
⊕	EXIST. POWER POLE	---	PROP. WATER SERVICE
⊕	EXIST. GUY WIRE	---	PROP. SANITARY SEWER
⊕	PROP. MANHOLE	---	PROP. STORM SEWER
⊕	PROP. INLET	---	PROP. WATER LINE
⊕	PROP. FIRE HYDRANT W/ GATE VALVE	---	PROP. ELECTRIC ROUTE
⊕	PROP. GATE VALVE	---	PROP. CABLE ROUTE
⊕	PROP. BLOW-OFF VALVE	---	PROP. TELEPHONE ROUTE
⊕	EXIST. FENCE	---	EXIST. CENTER PAVED DITCH
⊕	PROP. FIN. 'AD ELEVATION	---	EASEMENT LINE
		---	MINIMUM BUILDING SETBACK LINE

TR = TOP RIM ELEVATION
 TC = TOP CURB ELEVATION
 GL = GUTTER LINE ELEVATION
 ROW = SIGHT OF WAY

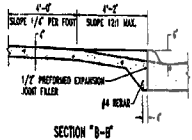
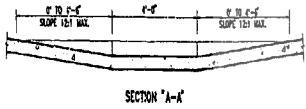
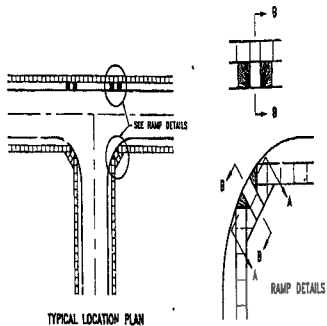

STANDARD HANDICAP RAMPS
 NOT TO SCALE

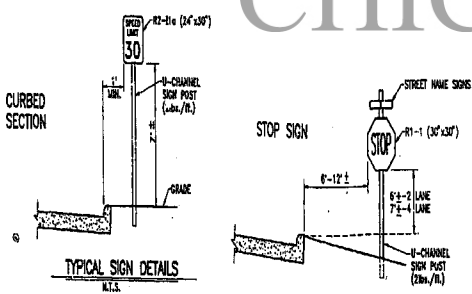

NOTE:
 ALL SIGNS AND INSTALLATION PER INDIANA DEPT. OF HIGHWAYS 1988
 MANUAL ON STANDARD TRAFFIC CONTROL DEVICES FOR STREETS AND HIGHWAYS

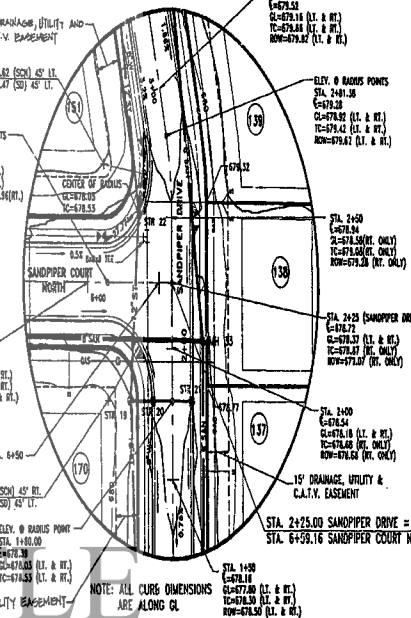
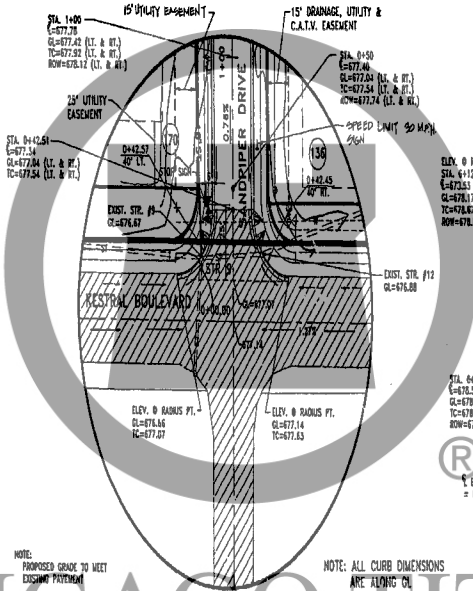
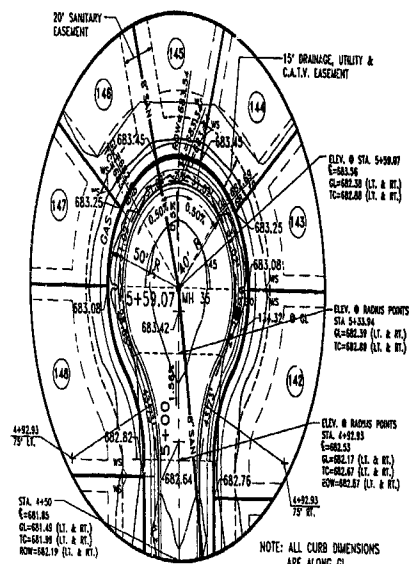
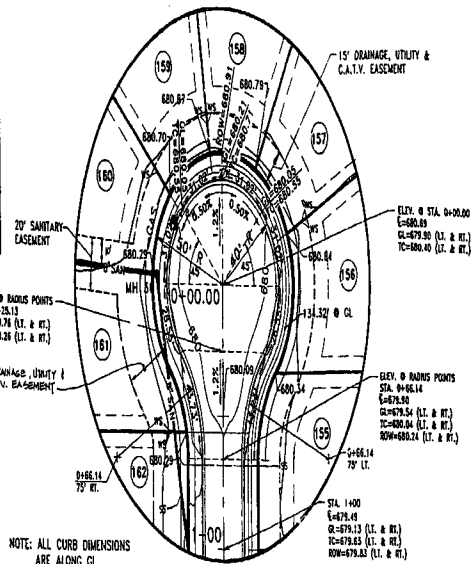

NOTES:
 1) ALL FRONT AND REAR YARD SETBACKS ARE 25 FEET UNLESS OTHERWISE NOTED.
 2) ALL SIDE YARD SETBACKS ARE 6 FEET UNLESS OTHERWISE NOTED.

REVISIONS		DATE		BY		CHECKED	

MISCELLANEOUS DETAILS			
PROJECT: BLACKBIRD FARMS, PHASE TWO, SECTION TWO			
DATE:	3-14-91	DRAWN BY:	
CHECKED BY:		SCALE:	
DATE:		PROJECT NO.:	

CHICAGO TITLE

TECH. SCHULTE & ASSOCIATES, P.C.
 CIVIL ENGINEERS-LAND SURVEYORS
 802 Columbia Street
 Lafayette, Indiana 47901
 Phone: (317) 743-0242
 FAX: (317) 429-5333

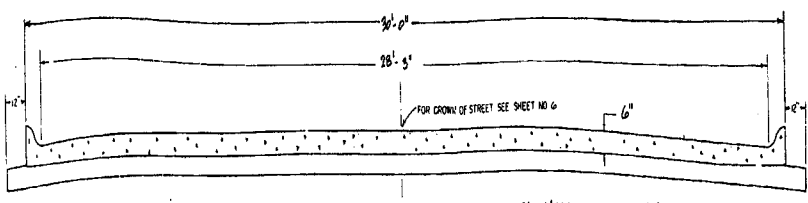

NOTE: BASE THICKNESS TO BE DETERMINED BY CITY ENGINEER

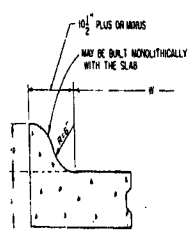

INTEGRAL CONCRETE CURB & GUTTER TYPE II
NOT TO SCALE

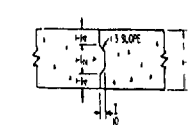

LONGITUDINAL CONSTRUCTION JOINT
NOT TO SCALE
NOTE: LONGITUDINAL JOINT MAY BE BUILT AS SHOWN IN DETAIL FOR TRANSVERSE CONTRACTION JOINT - THIS SHEET FOUR JOINT WITH APPROVED JOINT FILLER
NOTE: WHERE MORE THAN ONE JOINT IS USED, JOINTS WILL BE SYMMETRICAL ABOUT CENTER JOINT AND SPACES NOT MORE THAN 12 FEET

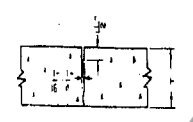

TRANSVERSE CONTRACTION JOINT
NOT TO SCALE
NOTE: SAWED, FORMED OR PREMOLDED RUBBER, POLY JOINT WITH APPROVED JOINT FILLER SPACED AT "J" DISTANCE - SEE TABLE BELOW - RANDOM DISTANCE (MAX. 14')

CORRELATION U.S. & SI UNITS
CONV. 0.07 (10)³

IN.	MM.
1	25.4
2	50.8
3	76.2
4	101.6
5	127.0
6	152.4
7	177.8
8	203.2
9	228.6
10	254.0
11	279.4
12	304.8
13	330.2
14	355.6
15	381.0
16	406.4
17	431.8
18	457.2
19	482.6
20	508.0
21	533.4
22	558.8
23	584.2
24	609.6
25	635.0
26	660.4
27	685.8
28	711.2
29	736.6
30	762.0
31	787.4
32	812.8
33	838.2
34	863.6
35	889.0
36	914.4
37	939.8
38	965.2
39	990.6
40	1016.0
41	1041.4
42	1066.8
43	1092.2
44	1117.6
45	1143.0
46	1168.4
47	1193.8
48	1219.2
49	1244.6
50	1270.0

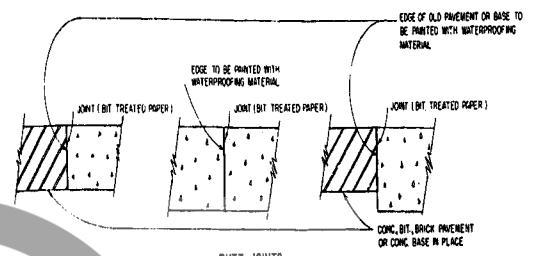

BUTT JOINTS
NOT TO SCALE
NOTE: IF TRANSVERSE JOINTS IN THE ADJACENT PAVEMENTS ARE IDENTICAL AS TO LOCATION AND TYPE, THE BITUMINOUS TREATED PAPER MAY BE OMITTED, IN WHICH CASE AN ADDITIONAL HEAVY APPLICATION OF WATERPROOFING SHALL BE SUBSTITUTED THEREFOR

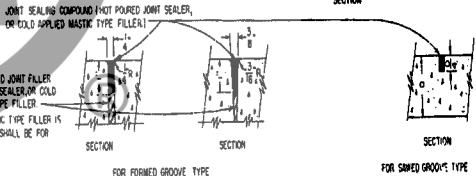
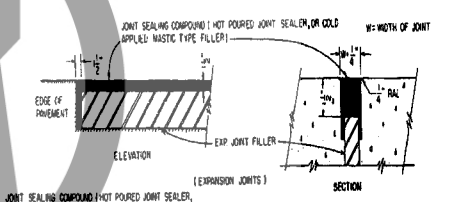

DETAILS OF SEAL FOR PAVEMENT CONTRACTION JOINTS
NOT TO SCALE

CHICAGO TITLE

SPECIFICATIONS, CONSTRUCTION SHALL BE IN ACCORDANCE WITH THE DESIGNATED SECTIONS OF THE INDIANA DEPT. OF TRANSPORTATION STANDARD SPECIFICATIONS FOR ROAD AND BRIDGE CONSTRUCTION AND MAINTENANCE - 1988

NOTE: STANDARDS AS SHOWN ON THIS SHEET SHOW MINIMUM CONSTRUCTION REQUIREMENTS, WHERE ENGINEERING STUDIES SHOW A NEED FOR INCREASING THESE REQUIREMENTS, THE DEVELOPER SHALL BE NOTIFIED BY THE CITY ENGINEER.

CLASS OF STREET	T	W	J	SUBGRADE		CURB
				THICKNESS	CONSTRUCTION	
MAJOR ARTERIAL	TO BE DETERMINED AS REQUIRED					
SECONDARY ARTERIAL	6"	MIN.	12"	SEE CURB	ASBESTOS	STD.
RESIDENTIAL	6"	MIN.	12"	SEE CURB	ASBESTOS	STD.

* WHERE MESH IS TO BE INSTALLED IT SHALL BE INSTALLED AS SET OUT IN THE INDIANA STANDARD SPECIFICATIONS FOR ROAD AND BRIDGE CONSTRUCTION

NOTE: CONCRETE MIX SHALL BE IN ACCORDANCE WITH ISHC STANDARDS, SECTION 501-03

* NOTE: NO CONCRETE PAVEMENT DEFICIENT IN THICKNESS WILL BE ACCEPTED. SECTION 50 23 (4 & e) OF THE INDIANA STATE HIGHWAY STANDARD SPECIFICATIONS IS NOT APPLICABLE. (MIN. THICKNESS 6")

ITEM	MATERIAL TYPE	SPECIFICATIONS SECTION
SUBGRADE	EARTH	507
PAVEMENT	PLAIN CONCRETE	501
PAVEMENT	REINFORCED CONCRETE	502
BASE		300
CURB	CONCRETE	605

INITIALS	DATE	REVISIONS
B.S.S.	5/2/78	ADD INTEGRAL CURB

RIGID PAVEMENT DETAILS

DATE 12/2/88

SHEET NO. 9 OF 13

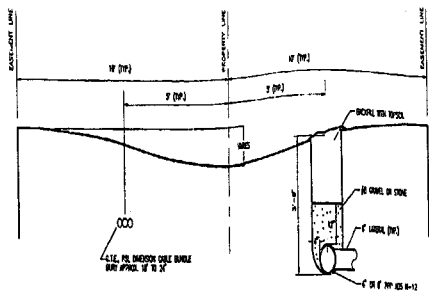

UTILITY LOCATIONS IN TRENCH
1/4"=1'-0"

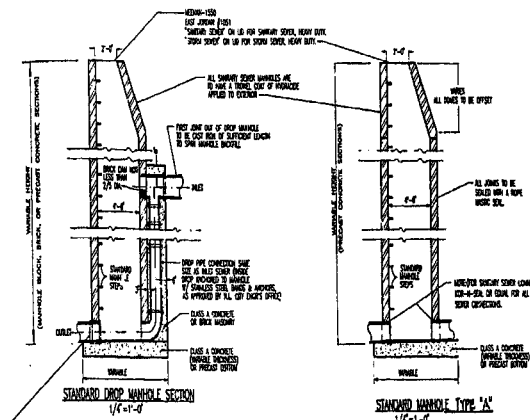

STANDARD DROP MANHOLE SECTION
1/4"=1'-0"

STANDARD MANHOLE TYPE 'A'
1/4"=1'-0"

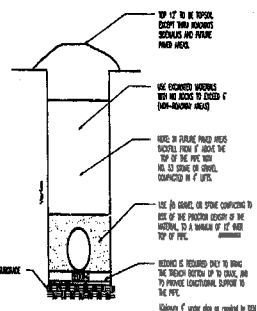

TRENCH DETAIL
1/4"=1'-0"

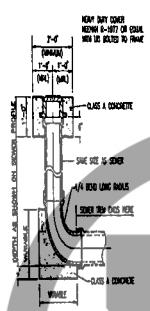

CLEANOUT SECTION
NOT TO SCALE

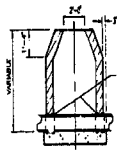

STANDARD MANHOLE
1/4"=1'-0"

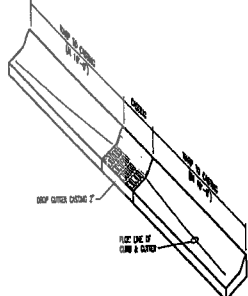

CONCRETE CURB AND GUTTER INLET DETAIL
1/4"=1'-0"

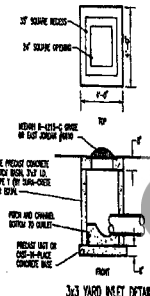

3/4 YARD INLET DETAIL
1/4"=1'-0"

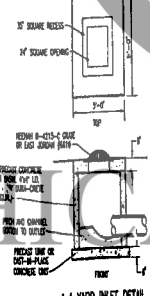

4/4 YARD INLET DETAIL
1/4"=1'-0"

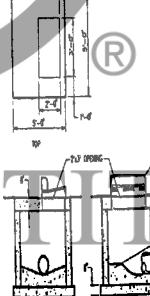

4/4 CURB INLET DETAIL
1/4"=1'-0"

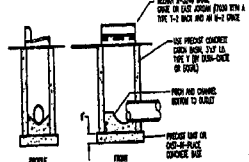

2x3 CURB INLET DETAIL
1/4"=1'-0"

CHICAGO TITLE

REVISIONS			DATE	
NO.	DATE	REVISION	BY	CHKD.

PROJECT		STORM AND SANITARY DETAILS	
BLACKBIRD FARMS, PHASE TWO, SECTION TWO			
SCALE	DATE	 TRENK, SIKSHT & ASSOCIATES, P.C. CIVIL ENGINEERS-LAND SURVEYORS 102 Columbia Street Maitland, Florida 32751 Phone (317) 742-4242 Fax: (317) 428-3333	10 13
DR. NO.	DATE		
DES. NO.	DATE		
CHECKED BY	DATE		
DATE	DATE		

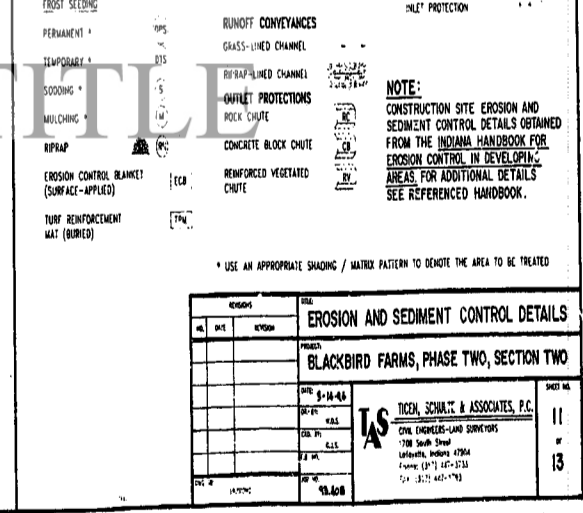
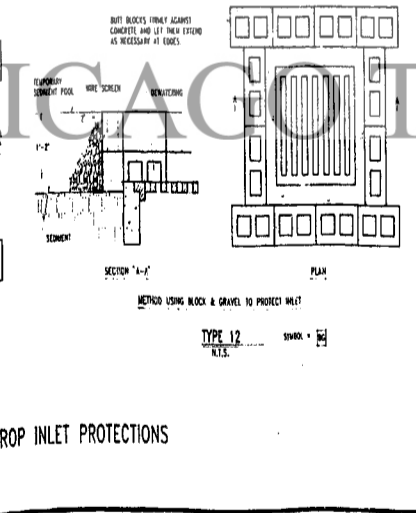
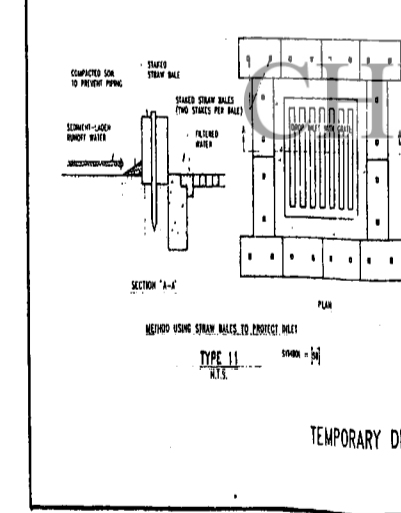
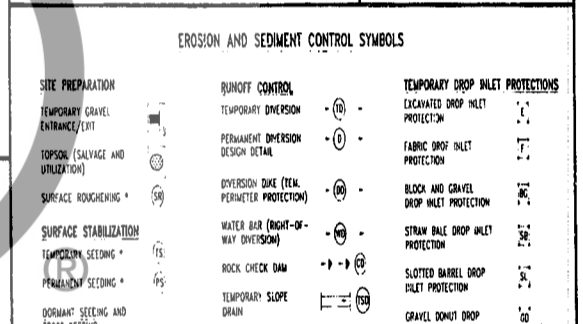
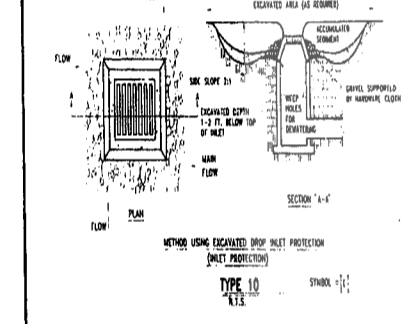
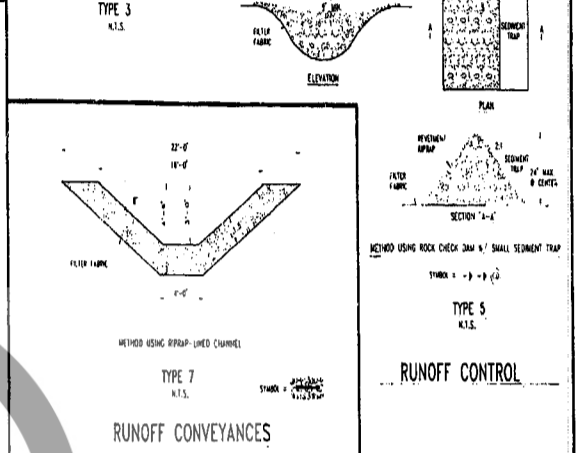
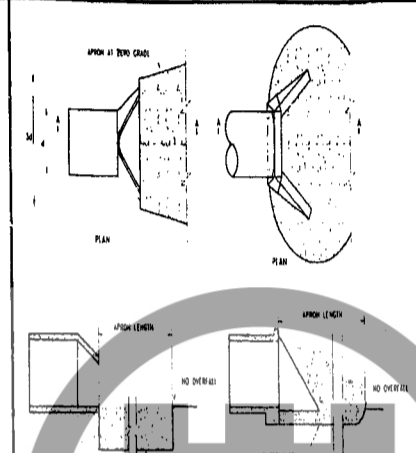
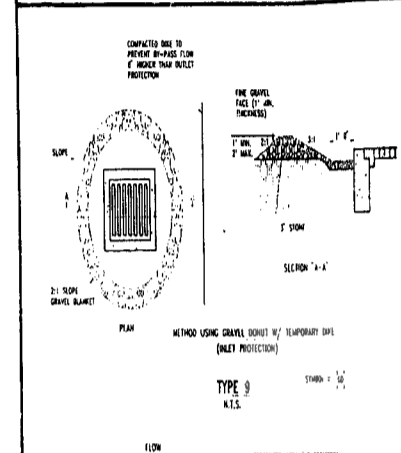
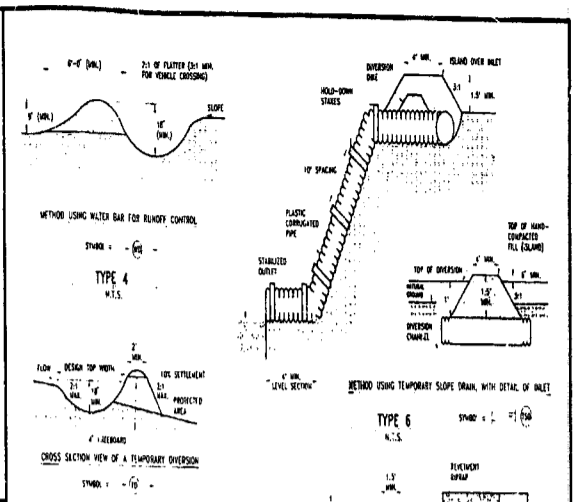
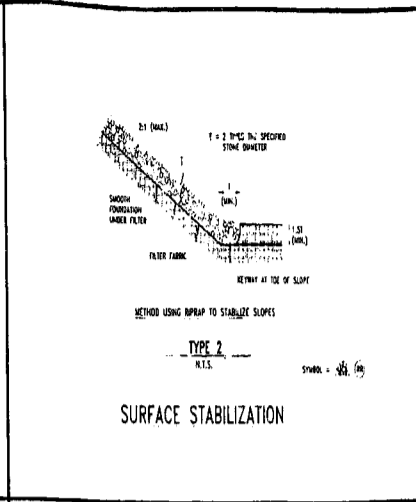
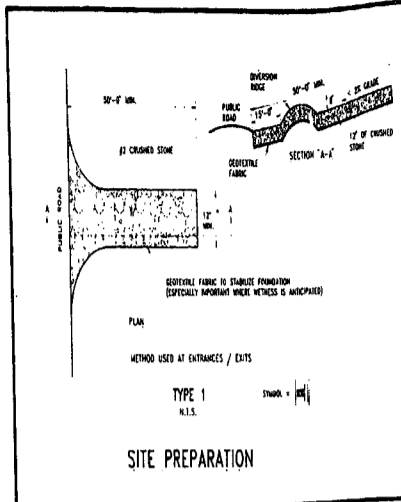

EROSION AND SEDIMENT CONTROL SYMBOLS

SITE PREPARATION	RUNOFF CONTROL	TEMPORARY DROP INLET PROTECTIONS
TEMPORARY GRAVEL ENTRANCE/EXIT	TEMPORARY DIVERSION	EXCAVATED DROP INLET PROTECTION
TOPSOIL (SALVAGE AND UTILIZATION)	PERMANENT DIVERSION DESIGN DETAIL	FABRIC DROP INLET PROTECTION
SURFACE ROUGHENING *	DIVERSION DIKE (TEMP. PERIMETER PROTECTION)	BLOCK AND GRAVEL DROP INLET PROTECTION
SURFACE STABILIZATION	WATER BAR (RIGHT-OF-WAY DIVERSION)	STRAW BALE DROP INLET PROTECTION
TEMPORARY SEEDING *	ROCK CHECK DAM	SLOTTED BARREL DROP INLET PROTECTION
PERMANENT SEEDING *	TEMPORARY SLOPE DRAIN	GRAVEL DONUT DROP INLET PROTECTION
DORMANT SEEDING AND FROST SEEDING	RUNOFF CONVEYANCES	
PERMANENT *	GRASS-LINED CHANNEL	
TEMPORARY *	RIPRAP-LINED CHANNEL	
SOODING *	OUTLET PROTECTIONS	
MULCHING *	ROCK CHUTE	
RIPRAP	CONCRETE BLOCK CHUTE	
EROSION CONTROL BLANKET (SURFACE-APPLIED)	REINFORCED VEGETATED CHUTE	
TURF REINFORCEMENT MAT (BURIED)		

NOTE: CONSTRUCTION SITE EROSION AND SEDIMENT CONTROL DETAILS OBTAINED FROM THE INDIANA HANDBOOK FOR EROSION CONTROL IN DEVELOPING AREAS. FOR ADDITIONAL DETAILS SEE REFERENCED HANDBOOK.

* USE AN APPROPRIATE SHAQING / MATRIX PATTERN TO DENOTE THE AREA TO BE TREATED

EROSION AND SEDIMENT CONTROL DETAILS			
NO.	DATE	REVISION	
PROJECT: BLACKBIRD FARMS, PHASE TWO, SECTION TWO			
DATE: 8-14-88		SHEET NO. 11 OF 13	
DRAWN BY: [Signature]		TICKET SCHWARTZ & ASSOCIATES, P.C.	
CHECKED BY: [Signature]		CIVIL ENGINEERS-LAND SURVEYORS	
SCALE: 1"=10'		1700 South Street	
DATE: 8-14-88		Lafayette, Indiana 47904	
DATE: 8-14-88		PHONE: (317) 487-3733	
DATE: 8-14-88		FAX: (317) 487-1793	

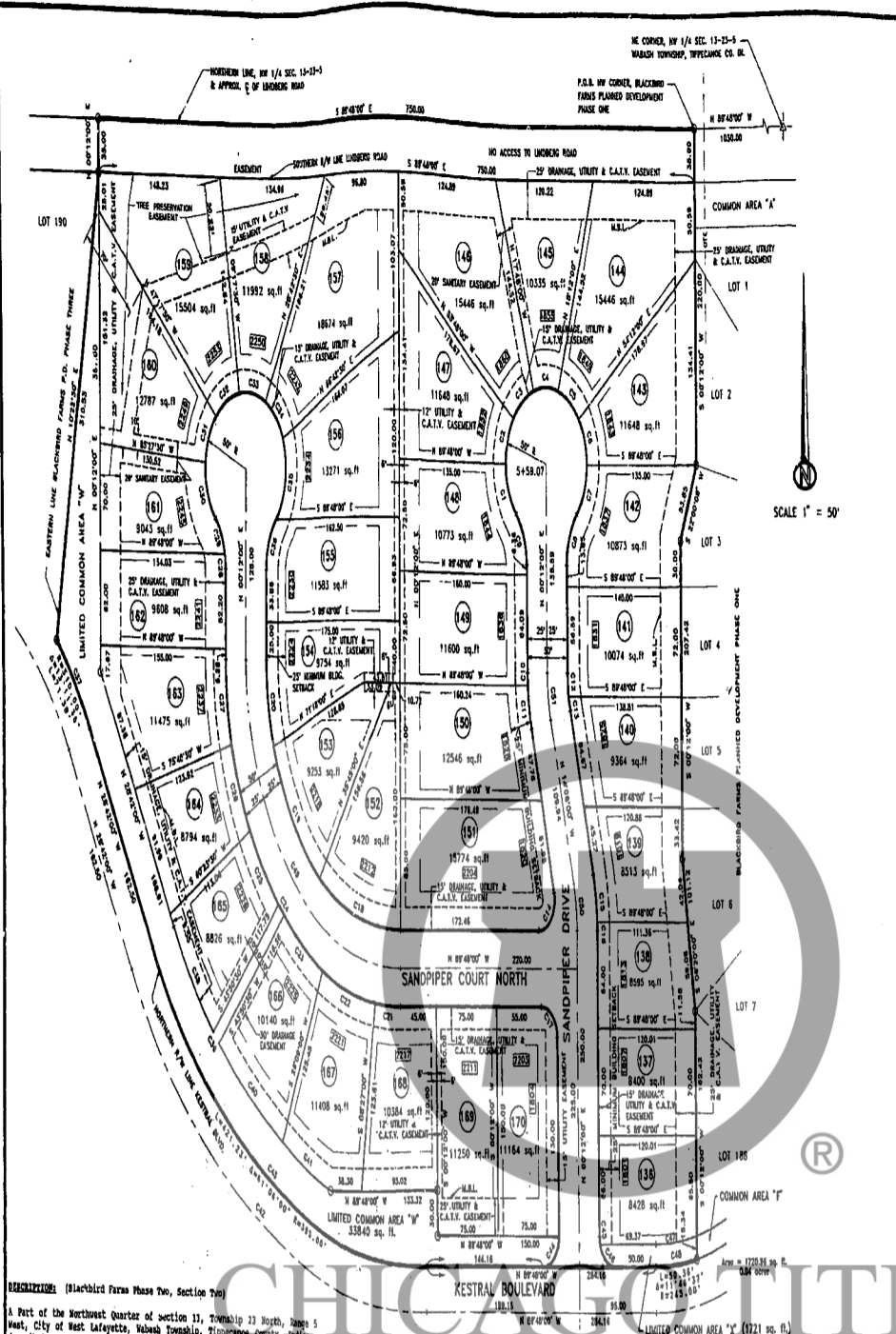

CH	BLK	ACRES	AREA	SHAPE	AREA	SHAPE	AREA	SHAPE	AREA	SHAPE	AREA	SHAPE	AREA	SHAPE	AREA
C1	174715	26.00	14.22	13.21	13.21	13.21	13.21	13.21	13.21	13.21	13.21	13.21	13.21	13.21	13.21
C2	174716	26.00	14.22	13.21	13.21	13.21	13.21	13.21	13.21	13.21	13.21	13.21	13.21	13.21	13.21
C3	174717	26.00	14.22	13.21	13.21	13.21	13.21	13.21	13.21	13.21	13.21	13.21	13.21	13.21	13.21
C4	174718	26.00	14.22	13.21	13.21	13.21	13.21	13.21	13.21	13.21	13.21	13.21	13.21	13.21	13.21
C5	174719	26.00	14.22	13.21	13.21	13.21	13.21	13.21	13.21	13.21	13.21	13.21	13.21	13.21	13.21
C6	174720	26.00	14.22	13.21	13.21	13.21	13.21	13.21	13.21	13.21	13.21	13.21	13.21	13.21	13.21
C7	174721	26.00	14.22	13.21	13.21	13.21	13.21	13.21	13.21	13.21	13.21	13.21	13.21	13.21	13.21
C8	174722	26.00	14.22	13.21	13.21	13.21	13.21	13.21	13.21	13.21	13.21	13.21	13.21	13.21	13.21
C9	174723	26.00	14.22	13.21	13.21	13.21	13.21	13.21	13.21	13.21	13.21	13.21	13.21	13.21	13.21
C10	174724	26.00	14.22	13.21	13.21	13.21	13.21	13.21	13.21	13.21	13.21	13.21	13.21	13.21	13.21
C11	174725	26.00	14.22	13.21	13.21	13.21	13.21	13.21	13.21	13.21	13.21	13.21	13.21	13.21	13.21
C12	174726	26.00	14.22	13.21	13.21	13.21	13.21	13.21	13.21	13.21	13.21	13.21	13.21	13.21	13.21
C13	174727	26.00	14.22	13.21	13.21	13.21	13.21	13.21	13.21	13.21	13.21	13.21	13.21	13.21	13.21
C14	174728	26.00	14.22	13.21	13.21	13.21	13.21	13.21	13.21	13.21	13.21	13.21	13.21	13.21	13.21
C15	174729	26.00	14.22	13.21	13.21	13.21	13.21	13.21	13.21	13.21	13.21	13.21	13.21	13.21	13.21
C16	174730	26.00	14.22	13.21	13.21	13.21	13.21	13.21	13.21	13.21	13.21	13.21	13.21	13.21	13.21
C17	174731	26.00	14.22	13.21	13.21	13.21	13.21	13.21	13.21	13.21	13.21	13.21	13.21	13.21	13.21
C18	174732	26.00	14.22	13.21	13.21	13.21	13.21	13.21	13.21	13.21	13.21	13.21	13.21	13.21	13.21
C19	174733	26.00	14.22	13.21	13.21	13.21	13.21	13.21	13.21	13.21	13.21	13.21	13.21	13.21	13.21
C20	174734	26.00	14.22	13.21	13.21	13.21	13.21	13.21	13.21	13.21	13.21	13.21	13.21	13.21	13.21
C21	174735	26.00	14.22	13.21	13.21	13.21	13.21	13.21	13.21	13.21	13.21	13.21	13.21	13.21	13.21
C22	174736	26.00	14.22	13.21	13.21	13.21	13.21	13.21	13.21	13.21	13.21	13.21	13.21	13.21	13.21
C23	174737	26.00	14.22	13.21	13.21	13.21	13.21	13.21	13.21	13.21	13.21	13.21	13.21	13.21	13.21
C24	174738	26.00	14.22	13.21	13.21	13.21	13.21	13.21	13.21	13.21	13.21	13.21	13.21	13.21	13.21
C25	174739	26.00	14.22	13.21	13.21	13.21	13.21	13.21	13.21	13.21	13.21	13.21	13.21	13.21	13.21
C26	174740	26.00	14.22	13.21	13.21	13.21	13.21	13.21	13.21	13.21	13.21	13.21	13.21	13.21	13.21
C27	174741	26.00	14.22	13.21	13.21	13.21	13.21	13.21	13.21	13.21	13.21	13.21	13.21	13.21	13.21
C28	174742	26.00	14.22	13.21	13.21	13.21	13.21	13.21	13.21	13.21	13.21	13.21	13.21	13.21	13.21
C29	174743	26.00	14.22	13.21	13.21	13.21	13.21	13.21	13.21	13.21	13.21	13.21	13.21	13.21	13.21
C30	174744	26.00	14.22	13.21	13.21	13.21	13.21	13.21	13.21	13.21	13.21	13.21	13.21	13.21	13.21
C31	174745	26.00	14.22	13.21	13.21	13.21	13.21	13.21	13.21	13.21	13.21	13.21	13.21	13.21	13.21
C32	174746	26.00	14.22	13.21	13.21	13.21	13.21	13.21	13.21	13.21	13.21	13.21	13.21	13.21	13.21
C33	174747	26.00	14.22	13.21	13.21	13.21	13.21	13.21	13.21	13.21	13.21	13.21	13.21	13.21	13.21
C34	174748	26.00	14.22	13.21	13.21	13.21	13.21	13.21	13.21	13.21	13.21	13.21	13.21	13.21	13.21
C35	174749	26.00	14.22	13.21	13.21	13.21	13.21	13.21	13.21	13.21	13.21	13.21	13.21	13.21	13.21
C36	174750	26.00	14.22	13.21	13.21	13.21	13.21	13.21	13.21	13.21	13.21	13.21	13.21	13.21	13.21
C37	174751	26.00	14.22	13.21	13.21	13.21	13.21	13.21	13.21	13.21	13.21	13.21	13.21	13.21	13.21
C38	174752	26.00	14.22	13.21	13.21	13.21	13.21	13.21	13.21	13.21	13.21	13.21	13.21	13.21	13.21
C39	174753	26.00	14.22	13.21	13.21	13.21	13.21	13.21	13.21	13.21	13.21	13.21	13.21	13.21	13.21
C40	174754	26.00	14.22	13.21	13.21	13.21	13.21	13.21	13.21	13.21	13.21	13.21	13.21	13.21	13.21

REGISTRATION CERTIFICATE

By the undersigned, G & L Development Co., Inc., by Bruce A. Sunkin, President, and William H. Long, Vice President, owners of the real estate shown and described herein, do hereby lay off, plat and subdivide said real estate in accordance with the hereto attached plat.

This Planned Development shall be known and designated as **BLACKBIRD FARMS PLANNED DEVELOPMENT, PHASE TWO, SECTION TWO**, an addition to the City of West Lafayette, Wabash Township, Tippecanoe County, State of Indiana. All streets and alleys and public open spaces shown and not heretofore dedicated are hereby dedicated to the public.

Front and side yard building setback lines are hereby established as shown on the plat, between which lines and the property lines of the street there shall be erected or maintained no building or structure.

EASEMENTS - Easements for installation and maintenance of utilities, C.A.T.V., and drainage facilities are reserved as shown on the recorded plat. Within these easements, no structure, planting or other material shall be placed or permitted to remain which may damage or interfere with the installation and maintenance of utilities or which may change the direction of flow of drainage channels in the easement or which may obstruct or retard the flow of water through drainage channels in the easements. The easement area of each lot and all improvements in it shall be maintained continuously by the owner of the lot, except for those improvements of which a public authority or utility company is responsible.

RESTRICTIVE COVENANTS - All lots are subject to certain restrictions recorded in Document Number 94855, in the Office of the Recorder for Tippecanoe County, Indiana.

The foregoing covenants (or restrictions) are to run with the land and shall be binding on all parties and all persons claiming under them until January 1, 2001, at which time said covenants (or restrictions) shall be automatically extended for successive periods of ten (10) years unless by vote of a majority of the then owners of the building sites covered by these covenants (or restrictions) it is agreed to change such covenants (or restrictions) in whole or in part.

The right to enforce these provisions by injunction, together with the right to cause the removal by the process of law of any structure or part thereof erected or maintained in violation hereof, is hereby dedicated to the public, and reserved to the several owners of the several lots in this subdivision and to their heirs and assigns.

WITNESS OUR HANDS AND SEALS THIS 26TH DAY OF APRIL, 1994.

G & L DEVELOPMENT, INC. by Bruce A. Sunkin
 Bruce A. Sunkin, President
William H. Long
 William H. Long, Vice-President

STATE OF INDIANA) SS:
 TIPPECANOE COUNTY)
 Before me, the undersigned Notary Public, in and for the County and State, personally appeared before me G & L Development, Inc., by Bruce A. Sunkin, President, and William H. Long, Vice-President, and acknowledged the execution of the foregoing instrument as his voluntary act and deed, for the purpose therein expressed.

WITNESS MY HAND AND NOTARIAL SEAL THIS 26TH DAY OF APRIL, 1994.
Russell W. Picon
 Notary Public, Russell W. Picon
 My Commission expires: August 18, 1994

OWNER: G & L DEVELOPMENT CO., INC. TAX KEY NUMBER: 170-05702-0023

REVISION				FINAL PLAT			
NO.	DATE	BY	REASON	NO.	DATE	BY	REASON

BLACKBIRD FARMS, PHASE TWO, SECTION TWO

DATE: 4-26-94
 BY: R.W.P.
 FOR: G & L
 TITLE: FINAL PLAT

TS
TEWEN SCHULTE & ASSOCIATES, P.C.
 CIVIL ENGINEERS-LAND SURVEYORS
 802 Columbia Tower
 Chicago, Illinois 60611
 Phone: (312) 742-4242
 Fax: (312) 742-5533

SHEET NO. 13 OF 13

DESCRIPTION: (Blackbird Farms Phase Two, Section Two)

A Part of the Northwest Quarter of section 31, Township 23 North, Range 5 West, City of West Lafayette, Wabash Township, Tippecanoe County, Indiana, described as follows:

Beginning at a point on the northern line of the Northwest Quarter of said Section 31, said point being located North 89°48'00" West, 1,430.00 feet from the southeastern corner of the Northwest Quarter of said Section 31, said point also being the northwestern corner of Blackbird Farms Planned Development Phase One; thence, traversing the western line of said Blackbird Farms Planned Development Phase One; the following line of said Blackbird Farms Planned Development Phase Two; thence, South 22°00'00" West, 53.45 feet; thence South 00°12'00" West, 207.42 feet; thence South 08°20'00" East, 101.11 feet; thence South 00°14'00" West, 192.42 feet to the northern right-of-way line of Kestral Boulevard; thence, traversing the northern right-of-way line of Kestral Boulevard the following four (4) courses: Southwesterly on a curve to the right, having a central angle of 117°44'33", a radius of 245.00 feet, an arc distance of 58.38 feet; thence North 89°48'00" West, 264.16 feet; thence Northwesterly on a tangent curve to the right, having a central angle of 117°44'33", a radius of 245.00 feet, an arc distance of 111.23 feet; thence North 20°41'00" West, 129.50 feet; thence Northwesterly on a tangent curve to the left, having a central angle of 17°11'35", a radius of 310.00 feet, an arc distance of 71.38 feet to the eastern line of Blackbird Farms Planned Development Phase Three; thence North 18°22'30" East, along the eastern line of said Blackbird Farms Planned Development Phase Three, 310.51 feet to the southern right-of-way line of Lindberg Road; thence North 00°12'00" East, 35.00 feet to the northern line of the Northwest Quarter of said Section 31; thence South 89°48'00" East, along the northern line of the Northwest Quarter of said Section Thirteen, 750.00 feet to the point of beginning, containing 12.049 acres, more or less.

The above bearings are based on Blackbird Farms Planned Development.

LEGEND

MINIMUM BUILDING SETBACK LINE

EASEMENT LINE

RIGHT OF WAY LINE

NOTES:

- 1) ALL FRONT AND REAR YARD SETBACKS ARE 25 FEET UNLESS OTHERWISE NOTED.
- 2) ALL SIDE YARD SETBACKS ARE 6 FEET UNLESS OTHERWISE NOTED.
- 3) DENOTES STREET ADDRESS 17341

LAND SURVEYOR'S CERTIFICATE:

I, Russell W. Picon, do hereby certify that I am a registered professional Land Surveyor of the State of Indiana; that this plat correctly represents a survey completed by me on March 24, 1994; that all the monuments shown thereon actually exist, and their location, size, type, and material are accurately shown; and that the computed error of closure of the boundary survey is not more than one (1) foot in ten thousand (10,000) feet; and that this plat complies with the provisions of the subdivision ordinance.

Russell W. Picon
 Russell W. Picon, L.S. #1441